

Catalogue

Series P3N-2C/O Relay

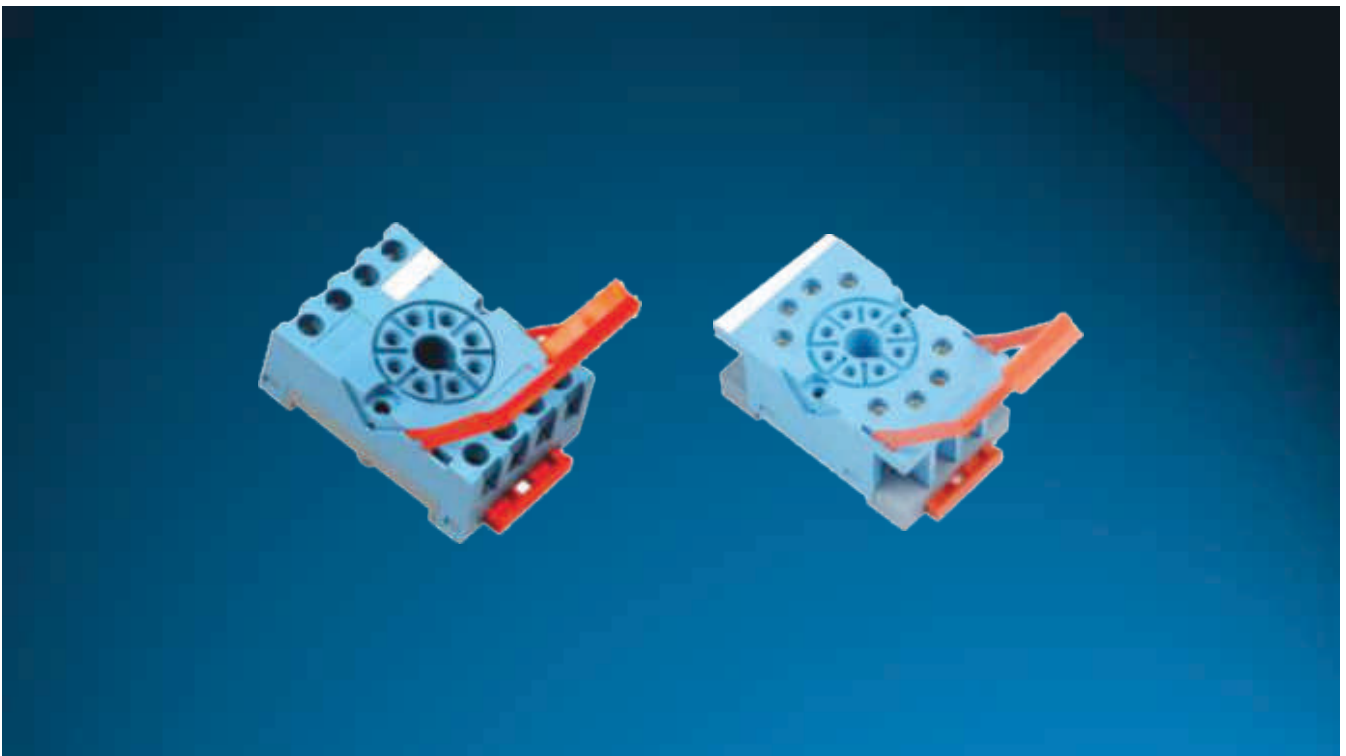

Benefits
of the new

Plus
system

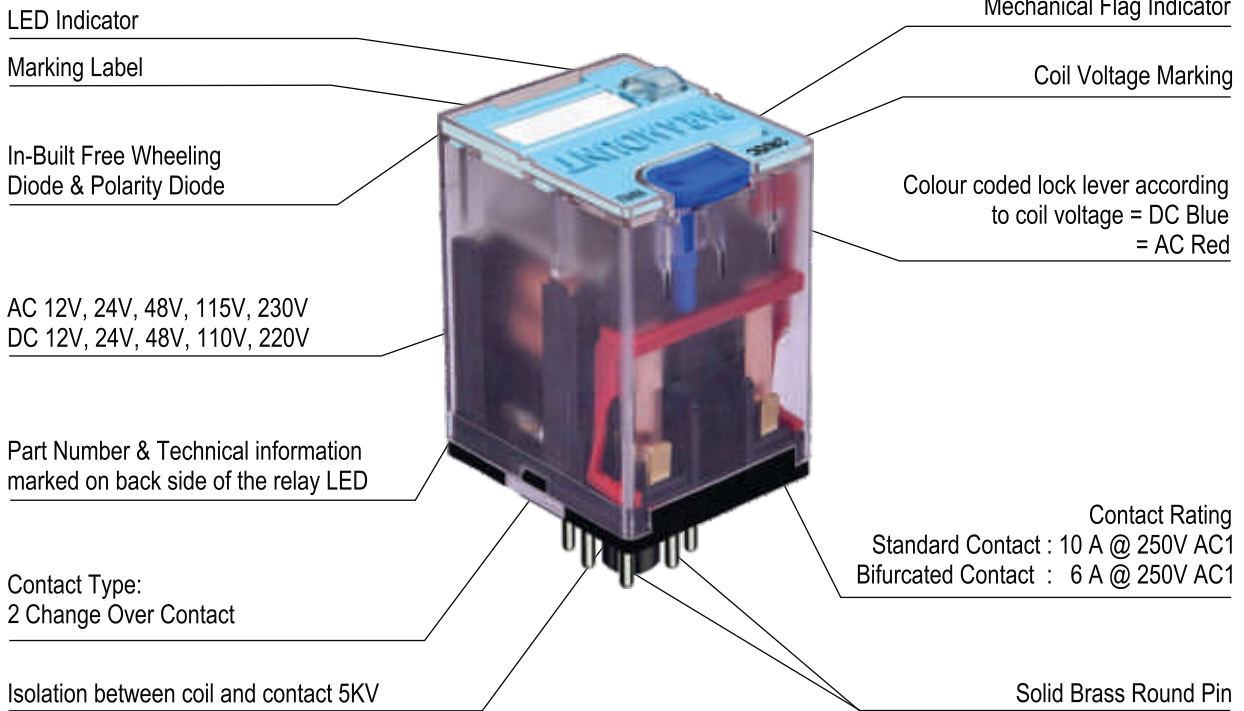

P3N-2 is a Two Pole Industrial Plug In Relay with all the In-built Mechanical and Electronic Features.

OPERATION FOR MANUAL AND LOCKABLE PUSH BUTTON

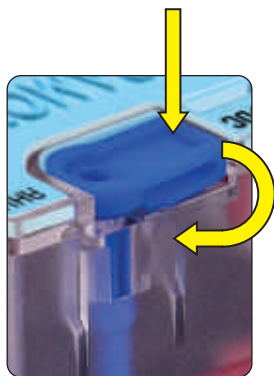

Press the Slot on Top with the help of Screw Driver for Manual Lock



Turn the button 90 Degree for Activating the Lockable Button

Mechanically Lock the Lockable Button in the OFF Position

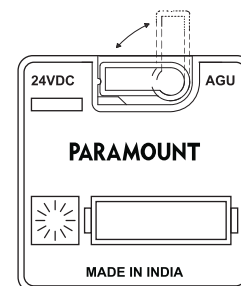
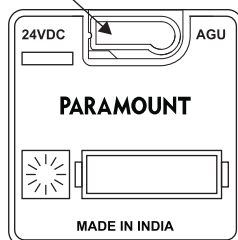



P3N-2

General Purpose 2 C/O Contacts
10 A 250V AC1 0.5 A 110V DC1
10 A 30V DC1 0.2 A 220V DC1

Contacts

Materials : Standard
 Optional 1 AgNi
 Optional 2 AgNi + Au 0.2 μ
 AgNi + Au 5.0 μ

Max. Switching Current 10A
 Max. Peak Inrush Current (20 ms) 30A
 Max. Switching Voltage 250 VAC
 Switching Power range 0.3 VA (W) to 2500 VA
 Max. Contact Resistance 20m Ω
 Max. AC Load (Table 1) 2.5 KVA
 Max. DC Load (See Table 2) -

Coils (Ohms ± 10% @ 20°C)
 Pull-in Voltage ≤ 0.8xUn
 Drop-out Voltage 0.1xUn
 Nominal Coil Power 2.5 VA (AC / 1.3 W (DC))

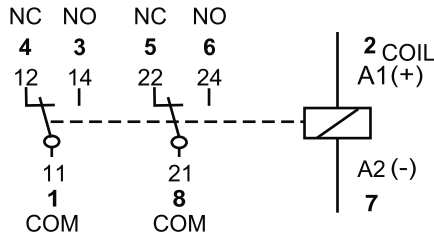

VAC	Ohms	VDC	Ohms
6	3.15	6	33
12	13.3	12	115
24	52	24	480
48	240	48	1850
110	1120	110	9000
230	5600	220	29000

Graph 1 Electrical life, ops x 10⁶

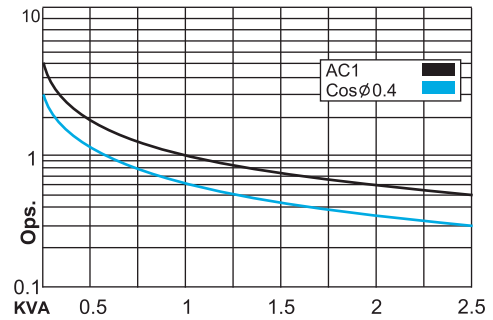

Graph 2 Max. DC load

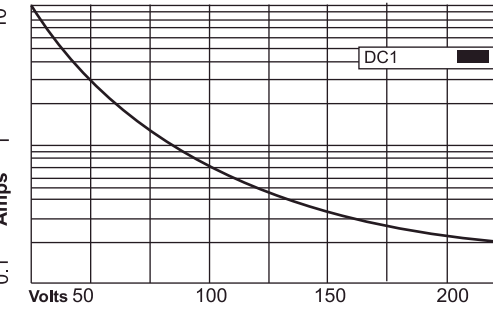

Dimensions in mm.

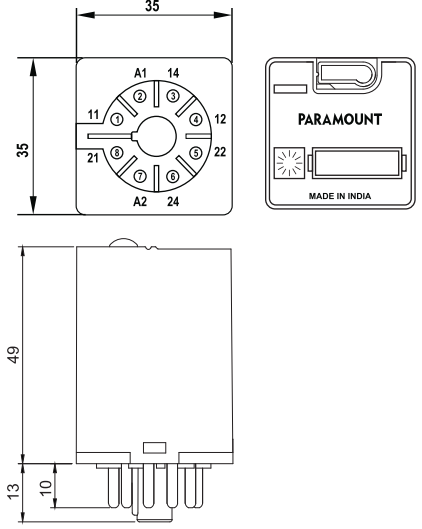

Insulation

Dielectric Strength (1 minute) : open contacts 1500 VAC
 Between adjacent poles 2000 VAC
 Between contacts and coil 2500 VAC
 Insulation Resistance @ 500VDC Min. ≥ 200 MΩ
 Isolation, IEC 61810-5 2.5 KV / 3

Specifications

Operate / Release & Bounce Time Max. for DC +3 / 3.5+ ms
 Operate / Release & Bounce Time Max. for AC 9+8 / 12+16 ms
 Mechanical Life ops. 10 Million AC, 20 Million DC relays
 Electrical life at Nominal load ≥ 100,000 ops.
 Operating Frequency at nominal load 1200 / hour
 Shock Resistance AK : > 10g
 Vibration Resistance 5g 10.....150 Hz
 Mounting Direction any
 Storage -40°C to +85°C
 Ambient Operating Temperature -40°C to +55°C (for AC relay)
 Ambient Operating Temperature -40°C to +70°C (for DC relay)
 Protection Standard IP 40
 Weight app. 80 g

Standard Types

AC : 6, 12, 24, 48, 110, 230	
F = Mechanical Flag Indicator	P3N-2-F VAC
P = LED Indicator	P3N-2-FP VAC
I = Lockable Push Button	P3N-2-FPI VAC
R = RC Snubber circuit (115 or 230V)	P3N-2-FIR VAC
DC : 6, 12, 24, 48, 110, 220	
F = Mechanical Flag Indicator	P3N-2-F VDC
P = LED	P3N-2-FP VDC
I = Lockable Push Button	P3N-2-FPI VDC
W = Free Wheeling Diode	P3N-2-FPIW VDC
Z = Polarity & Free Wheeling Diode	P3N-2-FPZI VDC
B = AC/DC Bridge Rectifier (24/48V)	P3N-2-FPIB VDC

Suitable Sockets : S8D, S8LD

Approvals



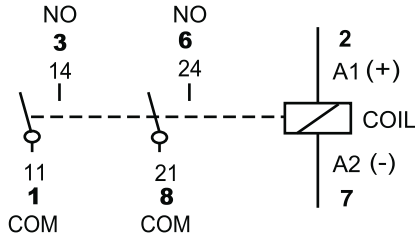

Graph 1 Electrical life, ops x 10⁶

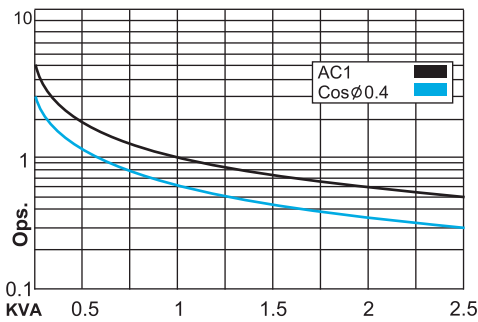

Graph 2 Max. DC load

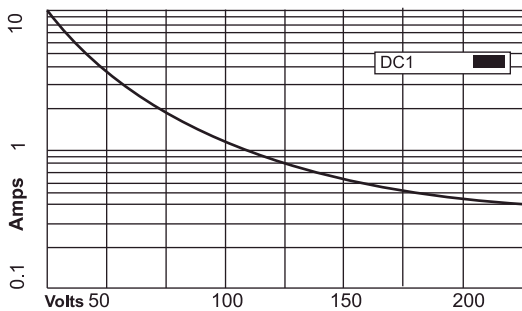

Dimensions in mm.

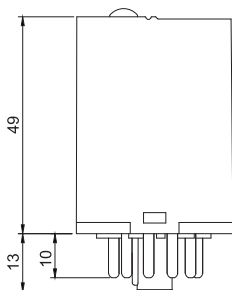
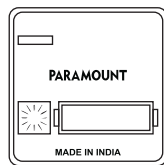
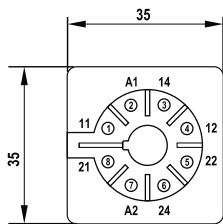

P3N-2A

General Purpose 2 NO Contacts
10 A 250V AC1 0.7 A 110V DC1
10 A 30V DC1 0.4 A 220V DC1

Contacts

Materials : Standard AgNi
Optional 1 AgNi + Au 0.2 μ
Optional 2 AgNi + Au 5.0 μ

Max. Switching Current 10A
Max. Peak Inrush Current (20 ms) 30A
Max. Switching Voltage 250 VAC
Switching Power range 0.3 VA (W) to 2500 VA
Max. Contact Resistance 20m Ω
Max. AC Load (Table 1) 2.5 KVA
Max. DC Load (See Table 2) -

Coils (Ohms ± 10% @ 20°C)

Pull-in Voltage ≤ 0.8xUn
Drop-out Voltage 0.1xUn
Nominal Coil Power 1.6 VA (AC / 1.3 W (DC))

VAC	Ohms	VDC	Ohms
6	3.15	6	33
12	13.3	12	115
24	52	24	480
48	240	48	1850
110	1120	110	9000
230	5600	220	29000

Insulation

Dielectric Strength (1 minute) : open contacts 2000 VAC
Between adjacent poles 2000 VAC
Between contacts and coil 2500 VAC
Insulation Resistance @ 500VDC Min. 200 MΩ
Isolation, IEC 61810-5 2.5 KV / 3

Specifications

Operate / Release & Bounce Time Max. for DC 20+3 ms
Operate / Release & Bounce Time Max. for AC 20+8 ms
Mechanical Life ops. 10 Million AC, 20 Million DC relays
Electrical life at Nominal load ≥ 100,000 ops.
Operating Frequency at nominal load 1200 / hour
Shock Resistance AK : > 10g
Vibration Resistance 5g 10.....150 Hz
Mounting Direction any
Storage -40°C to +85°C
Ambient Operating Temperature -40°C to +55°C (for AC relay)
Ambient Operating Temperature -40°C to +70°C (for DC relay)
Protection Standard IP 40
Weight app. 80 g

Standard Types

AC : 6, 12, 24, 48, 110, 230
F = Mechanical Flag Indicator
P = LED Indicator
R = RC Circuit

P3N-2A-F VAC
P3N-2A-FP VAC
P3N-2A-FR VAC

DC : 6, 12, 24, 48, 110, 220
F = Mechanical Flag Indicator
P = LED
W = Free Wheeling Diode
Z = Polarity & Free Wheeling Diode
B = AC/DC Bridge Rectifier

P3N-2A-F VDC
P3N-2A-FP VDC
P3N-2A-FPW VDC
P3N-2A-FPZ VDC
P3N-2A-FPB VDC

Suitable Sockets : S8D-YA, S8LD-YA

Approvals





P3N-X



General Purpose 1 NO + 1 NC Contacts

10 A 250V AC1 0.7 A 110V DC1

10 A 30V DC1 0.4 A 220V DC1

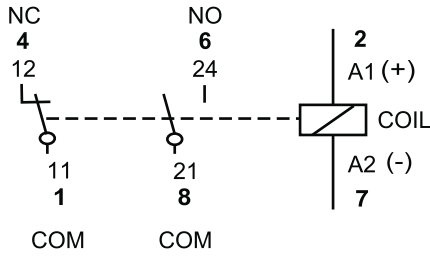

Contacts

Materials : Standard AgNi
Optional 1 AgNi + Au 0.2 μ
Optional 2 AgNi + Au 5.0 μ

Max. Switching Current 10A
Max. Peak Inrush Current (20 ms) 30A
Max. Switching Voltage 250 VAC
Switching Power range 0.3 VA (W) to 2500 VAZ
Max. Contact Resistance 20m Ω
Max. AC Load (Table 1) 2.5 KVA
Max. DC Load (See Table 2) -

Coils (Ohms ± 10% @ 20°C)
Pull-in Voltage ≤ 0.8xUn
Drop-out Voltage 0.1xUn
Nominal Coil Power 1.6 VA (AC / 1.3 W (DC))

VAC	Ohms	VDC	Ohms
6	3.15	6	33
12	13.3	12	115
24	52	24	480
48	240	48	1850
110	1120	110	9000
230	5600	220	29000

Graph 1 Electrical life, ops x 10⁶

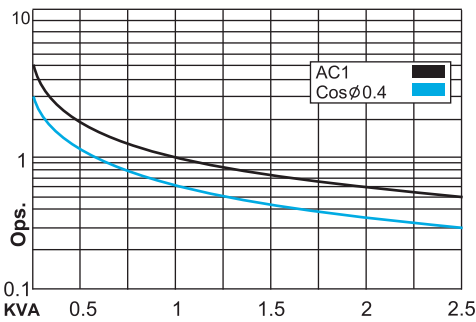

Graph 2 Max. DC load

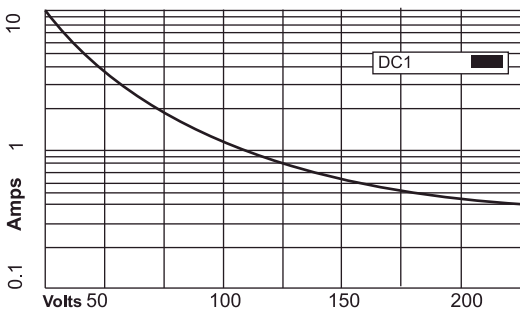

Dimensions in mm.

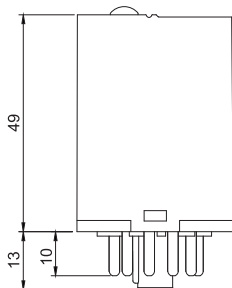
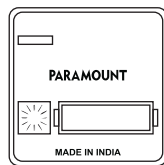
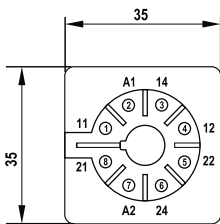

Insulation

Dielectric Strength (1 minute) : open contacts 2000 VAC
Between adjacent poles 2000 VAC
Between contacts and coil 2500 VAC
Insulation Resistance @ 500VDC Min. 200 MΩ
Isolation, IEC 61810-5 2.5 KV / 3

Specifications

Operate / Release & Bounce Time Max. for DC 20+3 ms
Operate / Release & Bounce Time Max. for AC 20+8 ms
Mechanical Life ops. 10 Million AC, 20 Million DC relays
Electrical life at Nominal load ≥ 50 ,000 ops.
Operating Frequency at nominal load 1200 / hour
Shock Resistance AK : > 10g
Vibration Resistance 5g 10.....150 Hz
Mounting Direction any
Storage -40°C to +85°C
Ambient Operating Temperature -40°C to +55°C (for AC relay)
Ambient Operating Temperature -40°C to +70°C (for DC relay)
Protection Standard IP 40
Weight app. 80 g

Standard Types

AC : 6, 12, 24, 48, 110, 230
F = Mechanical Flag Indicator P3N-X-F VAC
P = LED Indicator P3N-X-FP VAC
R = RC Circuit P3N-X-FR VAC

DC : 6, 12, 24, 48, 110, 220
F = Mechanical Flag Indicator P3N-X-F VDC
P = LED P3N-X-FP VDC
W = Free Wheeling Diode P3N-X-FPW VDC
Z = Polarity & Free Wheeling Diode P3N-X-FPZ VDC
B = AC/DC Bridge Rectifier P3N-X-FPB VDC

Suitable Sockets : S8D-X, S8LD-X

Approvals



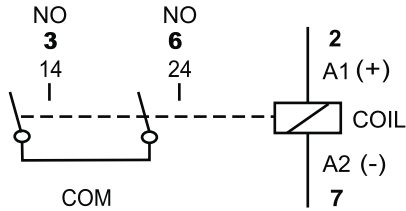

P3N-Y



General Purpose 1 NO Double Break

**10 A 250V AC1 7.0 A 110V DC1
10 A 30V DC1 1.2 A 220V DC1**

Contacts

Materials : Standard AgNi
Optional 1 AgNi + Au 0.2 μ
Optional 2 AgNi + Au 5.0 μ

Max. Switching Current 10A
Max. Peak Inrush Current (20 ms) 30A
Max. Switching Voltage 250 VAC
Switching Power range 0.3 VA (W) to 2500 VA
Max. Contact Resistance 20m Ω
Max. AC Load (Table 1) 2.5 KVA
Max. DC Load (See Table 2) -

Coils (Ohms ± 10% @ 20°C)

Pull-in Voltage ≤ 0.8 x Un
Drop-out Voltage 0.1 x Un

Nominal Coil Power 1.6 VA (AC / 1.3 W (DC))

VAC	Ohms	VDC	Ohms
6	3.15	6	33
12	13.3	12	115
24	52	24	480
48	240	48	1850
110	1120	110	9000
230	5600	220	29000

Graph 1 Electrical life, ops x 10⁶

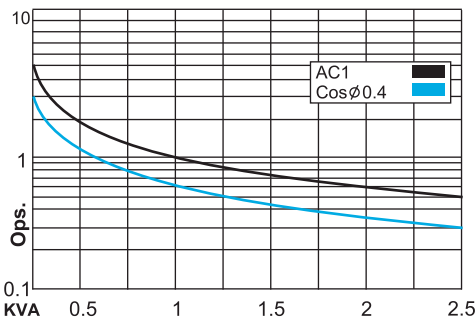

Graph 2 Max. DC load

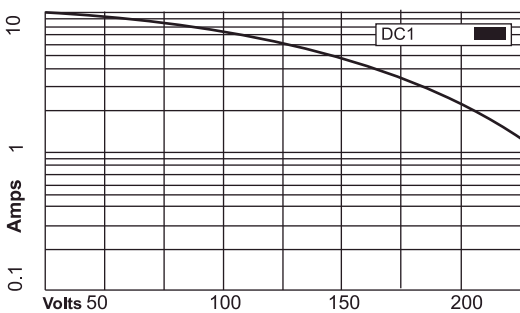

Dimensions in mm.

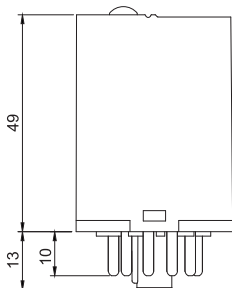
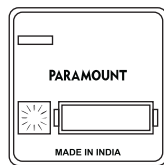
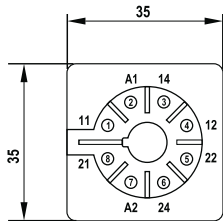

Insulation

Dielectric Strength (1 minute) : open contacts 2000 VAC
Between adjacent poles 2000 VAC
Between contacts and coil 2500 VAC
Insulation Resistance @ 500VDC Min. 200 MΩ
Isolation, IEC 61810-5 2.5 KV / 3

Specifications

Operate / Release & Bounce Time Max. for DC 20+3 ms
Operate / Release & Bounce Time Max. for AC 20+8 ms
Mechanical Life ops. 10 Million AC, 20 Million DC relays
Electrical life at Nominal load ≥ 100,000 ops.
Operating Frequency at nominal load 1200 / hour
Shock Resistance AK : > 10g
Vibration Resistance 5g 10.....150 Hz
Mounting Direction any
Storage -40°C to +85°C
Ambient Operating Temperature -40°C to +55°C (for AC relay)
Ambient Operating Temperature -40°C to +70°C (for DC relay)
Protection Standard IP 40
Weight app. 80 g

Standard Types

AC : 6, 12, 24, 48, 110, 230
F = Mechanical Flag Indicator P3N-Y-F VAC
P = LED Indicator P3N-Y-FP VAC
R = RC Circuit P3N-Y-FR VAC

DC : 6, 12, 24, 48, 110, 220
F = Mechanical Flag Indicator P3N-Y-F VDC
P = LED P3N-Y-FP VDC
W = Free Wheeling Diode P3N-Y-FPW VDC
Z = Polarity & Free Wheeling Diode P3N-Y-FPZ VDC
B = AC/DC Bridge Rectifier P3N-Y-FPB VDC

Suitable Sockets : S8D-YA, S8LD-YA

Approvals





P3N-2.....N



Magnetic Blow Out 2 NO Contacts

10 A 250V AC1 10 A 220V DC1
10 A 30V DC1 5 A 220V DC L/R 7ms

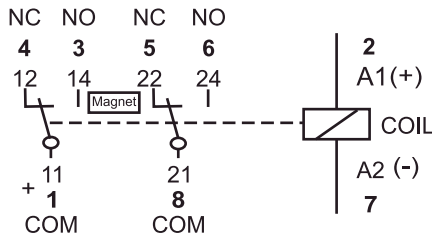

Graph 1 Electrical life, ops x 10⁶

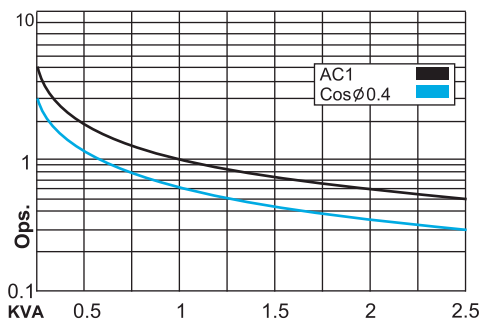

Graph 2 Max. DC load

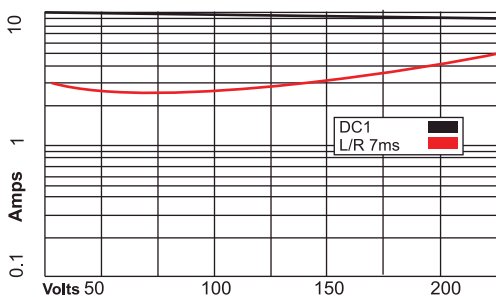

Dimensions in mm.

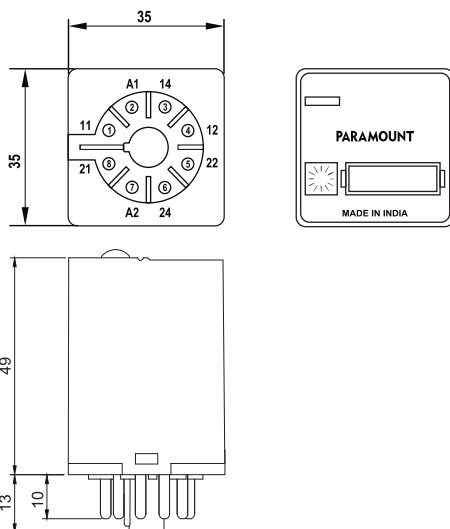

Contacts

Materials : Standard	AgNi
Optional 1	AgNi + Au 0.2 μ
Optional 2	AgNi + Au 5.0 μ
Max. Switching Current	10A
Max. Peak Inrush Current (20 ms)	30A
Max. Switching Voltage	250 VAC
Switching Power range	0.3 VA (W) to 2500 VA
Max. Contact Resistance	20m Ω
Max. AC Load (Table 1)	2.5 KVA

Coils (Ohms ± @ 20°C)

Pull-in Voltage	≤ 0.8xUn
Drop-out Voltage	≥ 0.1xUn
Nominal Coil Power	1.6 VA (AC / 1.3 W (DC))

VAC	Ohms	VDC	Ohms
6	3.15	6	33
12	13.3	12	115
24	52	24	480
48	240	48	1850
110	1120	110	9000
230	5600	220	29000

Insulation

Dielectric Strength (1 minute) : open contacts	1500 VAC
Between adjacent poles	2000 VAC
Between contacts and coil	2500 VAC
Insulation Resistance @ 500VDC Min.	200 MΩ
Isolation, IEC 61810-5	2.5 KV / 3

Specifications

Operate / Release & Bounce Time Max. for DC	16+3 / 3.5+8 ms
Operate / Release & Bounce Time Max. for AC	15+8 / 12+16 ms
Mechanical Life ops.	10 Million AC, 20 Million DC relays
Electrical life at Nominal load (NO)	≥ 100,000 ops.
Electrical life at Nominal load (NC)	≥ 50,000 ops.
Operating Frequency at nominal load	1200 / hour
Shock Resistance	AK : > 10g
Vibration Resistance	5g 10.....150 Hz
Mounting Direction	any
Storage	-40°C to +85°C
Ambient Operating Temperature	-40°C to +55°C (for AC relay)
Ambient Operating Temperature	-40°C to +70°C (for DC relay)
Protection Standard	IP 40
Weight	app. 80 g

Standard Types

AC : 6, 12, 24, 48, 110, 230	
M = Magnetic Blow Out	
P = LED Indicator	P3N-2-PN VAC
R = RC Circuit	P3N-2-PRN VAC
DC : 6, 12, 24, 48, 110, 220	
P = LED	P3N-2-PN VDC
W = Free Wheeling Diode	P3N-2-PWN VDC
Z = Polarity & Free Wheeling Diode	P3N-2-PZN VDC
B = AC/DC Bridge Rectifier	P3N-2-PBN VAD

Suitable Sockets : S8D, S8LD

Approvals



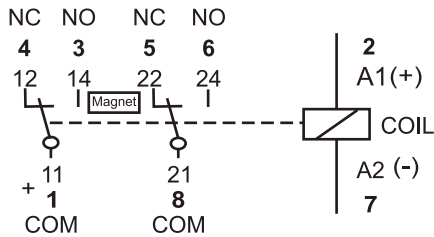

P3N-2.....M

Magnetic Blow Out 2 C/O Contacts

10 A 250V AC1 2.5 A 220V DC1 (NC)
10 A 30V DC1 5.0 A 220V DC1 (NO)
2 A 220V DC L/R 7ms (NC) 3 A 220V DC L/R 7ms (NO)

Contacts

Materials : Standard AgNi
 Optional 1 AgNi + Au 0.2 μ
 Optional 2 AgNi + Au 5.0 μ
 Max. Switching Current 10A
 Max. Peak Inrush Current (20 ms) 30A
 Max. Switching Voltage 250 VAC
 Switching Power range 0.3 VA (W) to 2500 VA
 Max. Contact Resistance 20m Ω
 Max. AC Load (Table 1) 2.5 KVA

Coils (Ohms ± @ 20°C)

Pull-in Voltage ≤ 0.8xUn
 Drop-out Voltage ≥ 0.1xUn

Nominal Coil Power		1.6 VA (AC / 1.3 W (DC))	
VAC	Ohms	VDC	Ohms
6	3.15	6	33
12	13.3	12	115
24	52	24	480
48	240	48	1850
110	1120	110	9000
230	5600	220	29000

Graph 1 Electrical life, ops x 10⁶

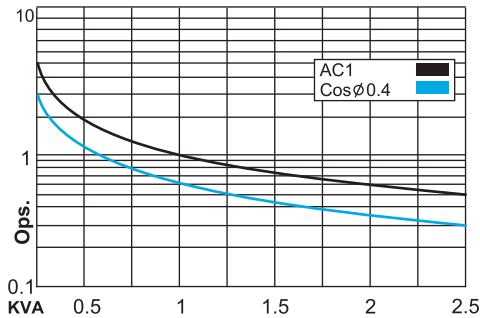

Graph 2 for NO load Max. DC load

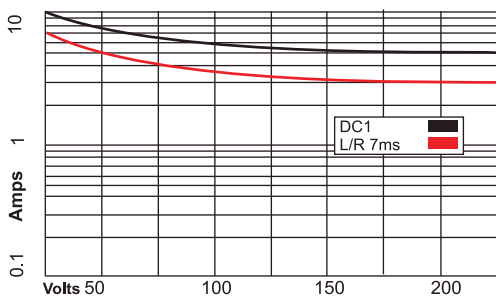

Dimensions in mm.

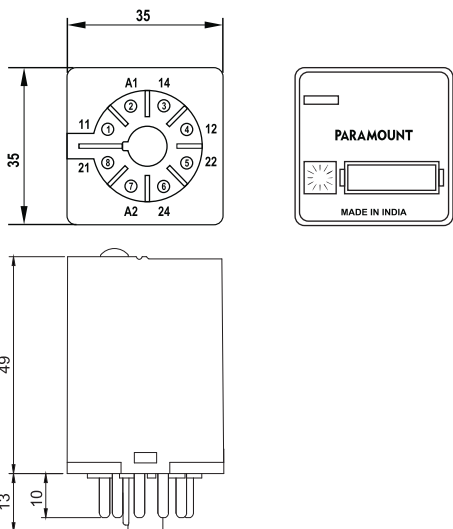

Insulation

Dielectric Strength (1 minute) : open contacts 1500 VAC
 Between adjacent poles 2000 VAC
 Between contacts and coil 2500 VAC
 Insulation Resistance @ 500VDC Min. 200 MΩ
 Isolation, IEC 61810-5 2.5 KV / 3

Specifications

Operate / Release & Bounce Time Max. for DC 16+3 / 3.5+8 ms
 Operate / Release & Bounce Time Max. for AC 15+8 / 12+16 ms
 Mechanical Life ops. 10 Million AC, 20 Million DC relays
 Electrical life at Nominal load (NO) ≥ 100,000 ops.
 Electrical life at Nominal load (NC) ≥ 50,000 ops.
 Operating Frequency at nominal load 1200 / hour
 Shock Resistance AK : > 10g
 Vibration Resistance 5g 10.....150 Hz
 Mounting Direction any
 Storage -40°C to +85°C
 Ambient Operating Temperature -40°C to +55°C (for AC relay)
 Ambient Operating Temperature -40°C to +70°C (for DC relay)
 Protection Standard IP 40
 Weight app. 80 g

Contact Make and Carry : 30A for 3 sec. and 5A continuously @ 660V

Standard Types

AC : 6, 12, 24, 48, 110, 230
M = Magnetic Blow Out
P = LED Indicator
R = RC Circuit
DC : 6, 12, 24, 48, 110, 220
P = LED
W = Free Wheeling Diode
Z = Polarity & Free Wheeling Diode
B = AC/DC Bridge Rectifier

P3N-2-PM VAC
P3N-2-PRM VAC
P3N-2-PM VDC
P3N-2-PWM VDC
P3N-2-PZM VDC
P3N-2-PBM VAD

Suitable Sockets : S8D, S8LD

Approvals



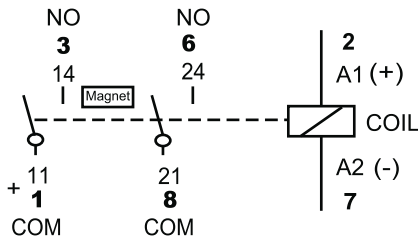

Graph 1 Electrical life, ops x 10⁶

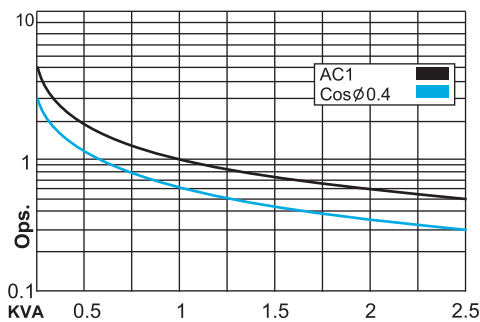

Graph 2 Max. DC load

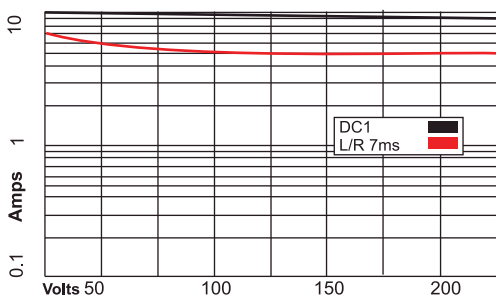

Dimensions in mm.

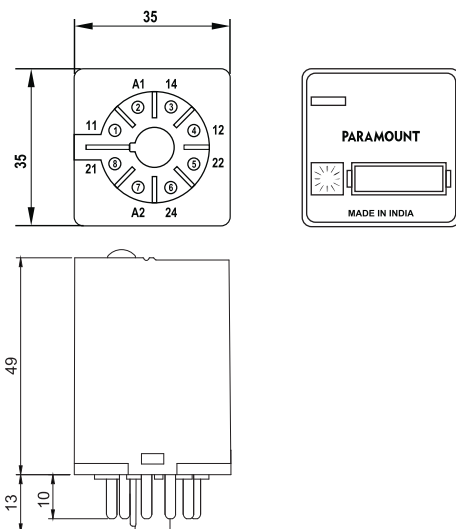

P3N-2A.....M



Magnetic Blow Out 2 NO Contacts

10 A 250V AC1 10 A 220V DC1
10 A 30V DC1 5 A 220V DC L/R 7ms

Contacts

Materials : Standard AgNi
Optional 1 AgNi + Au 0.2 μ
Optional 2 AgNi + Au 5.0 μ
Max. Switching Current 10A
Max. Peak Inrush Current (20 ms) 30A
Max. Switching Voltage 250 VAC
Switching Power range 0.3 VA (W) to 2500 VA
Max. Contact Resistance 20m Ω
Max. AC Load (Table 1) 2.5 KVA

Coils (Ohms ± 10% @ 20°C)

Pull-in Voltage 0.8xUn
Drop-out Voltage 0.1xUn
Nominal Coil Power 1.6 VA (AC / 1.3 W (DC))

VAC	Ohms	VDC	Ohms
6	3.15	6	33
12	13.3	12	115
24	52	24	480
48	240	48	1850
110	1120	110	9000
230	5600	220	29000

Insulation

Dielectric Strength (1 minute) : open contacts 2000 VAC
Between adjacent poles 2000 VAC
Between contacts and coil 2500 VAC
Insulation Resistance @ 500VDC Min. 200 MΩ
Isolation, IEC 61810-5 2.5 KV / 3

Specifications

Operate / Release & Bounce Time Max. for DC 20+3 ms
Operate / Release & Bounce Time Max. for AC 20+8 ms
Mechanical Life ops. 10 Million AC, 20 Million DC relays
Electrical life at Nominal load ≥ 100,000 ops.
Operating Frequency at nominal load 1200 / hour
Shock Resistance AK : > 10g
Vibration Resistance 5g 10.....150 Hz
Mounting Direction any
Storage -40°C to +85°C
Ambient Operating Temperature -40°C to +55°C (for AC relay)
Ambient Operating Temperature -40°C to +70°C (for DC relay)
Protection Standard IP 40
Weight app. 80 g

Contact Make and Carry : 30A for 3 sec. and 5A continuously @ 660V

Standard Types

AC : 6, 12, 24, 48, 110, 230

M = Magnetic Blow Out

P = LED Indicator

R = RC Circuit

P3N-2A-PM VAC

P3N-2A-PRM VAC

DC : 6, 12, 24, 48, 110, 220

P = LED

W = Free Wheeling Diode

Z = Polarity & Free Wheeling Diode

B = AC/DC Bridge Rectifier

P3N-2A-PM VDC

P3N-2A-PWM VDC

P3N-2A-PZM VDC

P3N-2A-PBM VDC

Suitable Sockets : S8D-YA, S8LD-YA

Approvals





P3N-X.....M



Magnetic Blow Out 1 NO + 1NC Contacts

10 A 250V AC1 10 A 220V DC1

10 A 30V DC1 5 A 220V DC L/R 7ms

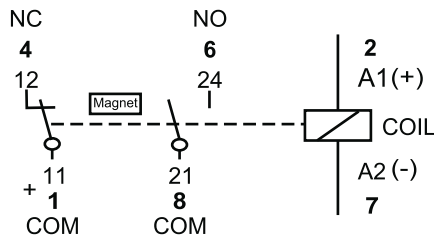

Contacts

Materials :	Standard	AgNi
	Optional 1	AgNi + Au 0.2 μ
	Optional 2	AgNi + Au 5.0 μ
Max. Switching Current		10A
Max. Peak Inrush Current (20 ms)		30A
Max. Switching Voltage		250 VAC
Switching Power range		0.3 VA (W) to 2500 VA
Max. Contact Resistance		20m Ω
Max. AC Load (Table 1)		2.5 KVA

Coils (Ohms ± 10% @ 20°C)

Pull-in Voltage	≤ 0.8 x Un
Drop-out Voltage	0.1 x Un

Nominal Coil Power 1.6 VA (AC / 1.3 W (DC))

VAC	Ohms	VDC	Ohms
6	3.15	6	33
12	13.3	12	115
24	52	24	480
48	240	48	1850
110	1120	110	9000
230	5600	220	29000

Graph 1 Electrical life, ops x 10⁶

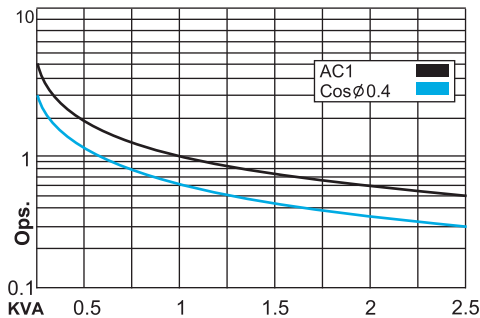

Graph 2 Max. DC load

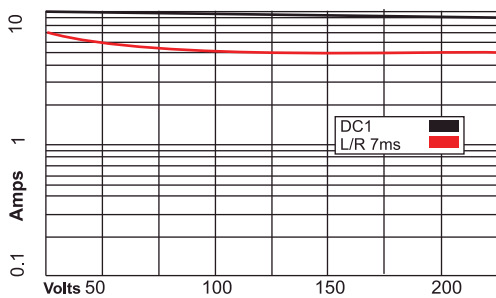

Dimensions in mm.

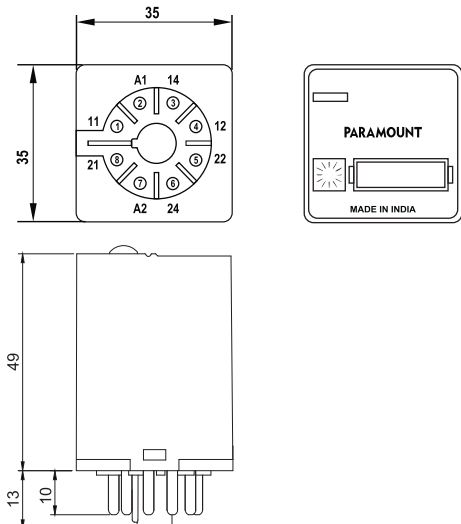

Insulation

Dielectric Strength (1 minute) : open contacts	2000 VAC
Between adjacent poles	2000 VAC
Between contacts and coil	2500 VAC
Insulation Resistance @ 500VDC Min.	200 MΩ
Isolation, IEC 61810-5	2.5 KV / 3

Specifications

Operate / Release & Bounce Time Max. for DC	20+3 ms
Operate / Release & Bounce Time Max. for AC	20+8 ms
Mechanical Life ops.	10 Million AC, 20 Million DC relays
Electrical life at Nominal load	≥ 100,000 ops.
Operating Frequency at nominal load	1200 / hour
Shock Resistance	AK : > 10g
Vibration Resistance	5g 10.....150 Hz
Mounting Direction	any
Storage	-40°C to +85°C
Ambient Operating Temperature	-40°C to +55°C (for AC relay)
Ambient Operating Temperature	-40°C to +70°C (for DC relay)
Protection Standard	IP 40
Weight	app. 80 g

Standard Types

AC : 6, 12, 24, 48, 110, 230

M = Magnetic Blow Out

P = LED Indicator

R = RC Circuit

P3N-X-PM VAC

P3N-X-PRM VAC

DC : 6, 12, 24, 48, 110, 220

P = LED

W = Free Wheeling Diode

Z = Polarity & Free Wheeling Diode

B = AC/DC Bridge Rectifier

P3N-X-PM VDC

P3N-X-PWM VDC

P3N-X-PZM VDC

P3N-X-PBM VDC

Suitable Sockets : S8D-X, S8LD-X

Approvals





P3N-Y.....M

Magnetic Blow Out 1 NO Double Break

10 A 250V AC1 10 A 220V DC1

10 A 30V DC1 7 A 220V DC L/R 7ms

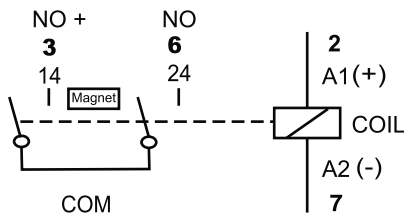

Contacts

Materials :	Standard	AgNi
	Optional 1	AgNi + Au 0.2 μ
	Optional 2	AgNi + Au 5.0 μ
Max. Switching Current		10A
Max. Peak Inrush Current (20 ms)		30A
Max. Switching Voltage		250 VAC
Switching Power range		0.3 VA (W) to 2500 VAZ
Max. Contact Resistance		20m Ω
Max. AC Load (Table 1)		2.5 KVA

Coils (Ohms ± 10% @ 20°C)

Pull-in Voltage	≤ 0.8 x Un
Drop-out Voltage	0.1 x Un
Nominal Coil Power	1.6 VA (AC / 1.3 W (DC))

VAC	Ohms	VDC	Ohms
6	3.15	6	33
12	13.3	12	115
24	52	24	480
48	240	48	1850
110	1120	110	9000
230	5600	220	29000

Graph 1 Electrical life, ops x 10⁶

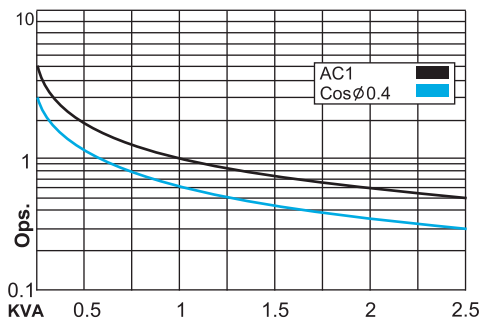

Graph 2 Max. DC load

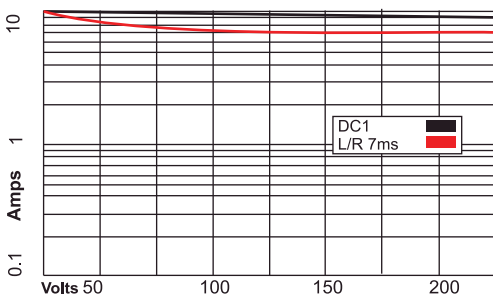

Dimensions in mm.

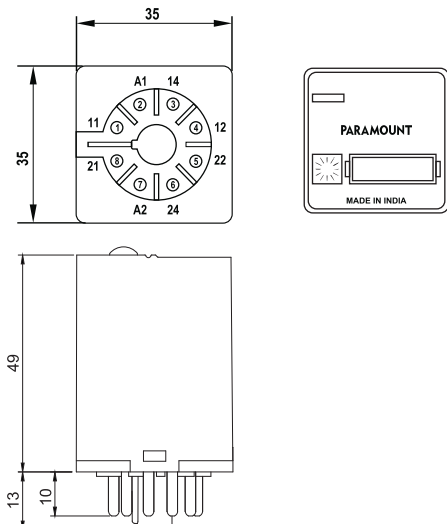

Insulation

Dielectric Strength (1 minute) : open contacts	1500 VAC
Between adjacent poles	2000 VAC
Between contacts and coil	2500 VAC
Insulation Resistance @ 500VDC Min.	200 MΩ
Isolation, IEC 61810-5	2.5 KV / 3

Specifications

Operate / Release & Bounce Time Max. for DC	15+3 ms
Operate / Release & Bounce Time Max. for AC	16+8 ms
Mechanical Life ops.	10 Million AC, 20 Million DC relays
Electrical life at Nominal load	≥ 100,000 ops.
Operating Frequency at nominal load	1200 / hour
Shock Resistance	AK : > 10g
Vibration Resistance	5g 10.....150 Hz
Mounting Direction	any
Storage	-40°C to +85°C
Ambient Operating Temperature	-40°C to +55°C (for AC relay)
Ambient Operating Temperature	-40°C to +70°C (for DC relay)
Protection Standard	IP 40
Weight	app. 80 g

Standard Types

AC : 6, 12, 24, 48, 110, 230

M = Magnetic Blow Out

P = LED Indicator

R = RC Circuit

P3N-Y-PM VAC
P3N-Y-PRM VAC

DC : 6, 12, 24, 48, 110, 220

P = LED

W = Free Wheeling Diode

Z = Polarity & Free Wheeling Diode

B = AC/DC Bridge Rectifier

P3N-Y-PM VDC
P3N-Y-PWM VDC
P3N-Y-PZM VDC
P3N-Y-PBM VDC

Suitable Sockets : S8D-YA, S8LD-YA

Approvals





P3N-2T

2C/O Bifurcated Contacts

6 A 250V AC1 0.5 A 110V DC1
6 A 30V DC1 0.2 A 220V DC1

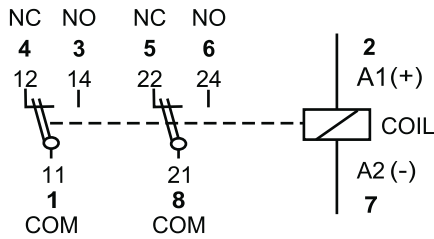

Graph 1 Electrical life, ops x 10⁶

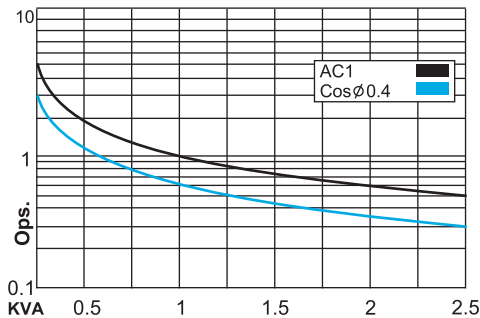

Graph 2 Max. DC load

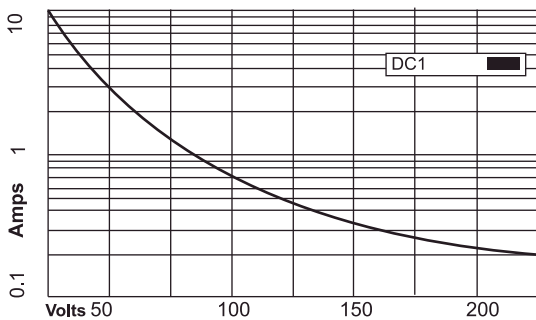

Dimensions in mm.

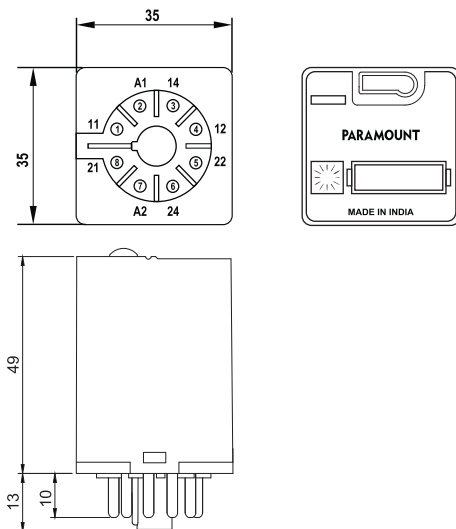

Contacts

Materials : Standard AgNi
Optional 1 AgNi + Au 0.2 μ
Optional 2 AgNi + Au 5.0 μ

Max. Switching Current 6A
Max. Peak Inrush Current (20 ms) 30A
Max. Switching Voltage 250 VAC
Switching Power range 0.3 VA (W) to 2500 VAzC
Max. Contact Resistance 20m Ω
Max. AC Load (Table 1) 2.5 KVA
Max. DC Load (See Table 2) -

Coils (Ohms ± 10% @ 20°C)

Pull-in Voltage 0.8xUn
Drop-out Voltage 0.1xUn
Nominal Coil Power 1.6 VA (AC / 1.3 W) (DC)

VAC	Ohms	VDC	Ohms
6	3.15	6	33
12	13.3	12	116
24	52	24	480
46	240	46	1850
110	1120	110	9000
230	5600	220	29000

Insulation

Dielectric Strength (1 minute) : open contacts 1500 VAC
Between adjacent poles 2000 VAC
Between contacts and coil 2500 VAC
Insulation Resistance @ 500VDC Min. 200 MΩ
Isolation, IEC 61810-5 2.5 KV / 3

Specifications

Operate / Release & Bounce Time Max. for DC 8+3 / 3.5+8 ms
Operate / Release & Bounce Time Max. for AC 9+8 / 12+16 ms
Mechanical Life ops. 10 Million AC, 20 Million DC relays
Electrical life at Nominal load ≥ 100,000 ops.
Operating Frequency at nominal load 1200 / hour
Shock Resistance AK : > 10g
Vibration Resistance 5g 10.....150 Hz
Mounting Direction any
Storage -40°C to +85°C
Ambient Operating Temperature -40°C to +55°C (for AC relay)
Ambient Operating Temperature -40°C to +70°C (for DC relay)
Protection Standard IP 40
Weight app. 80 g

Standard Types

AC : 6, 12, 24, 48, 110, 230

T = Twin Contact

F = Mechanical Flag Indicator

P = LED Indicator

I = Lockable Push Button

R = RC Circuit

DC : 6, 12, 24, 48, 110, 220

F = Mechanical Flag Indicator

P = LED

I = Lockable Push Button

W = Free Wheeling Diode

Z = Polarity & Free Wheeling Diode

B = AC/DC Bridge Rectifier

P3N-2T-F VAC
P3N-2T-FP VAC
P3N-2T-FPI VAC
P3N-2T-FIR VAC

P3N-2T-F VDC
P3N-2T-FP VDC
P3N-2T-FPI VDC
P3N-2T-FPIW VDC
P3N-2T-FPZI VDC
P3N-2T-FPIB VDC

Suitable Sockets : S8D, S8LD

Approvals





P3N-2.....E

General Purpose 2C/O Relays

6 A 250V AC1 0.5 A 110V DC1
6 A 30V DC1 0.2 A 220V DC1

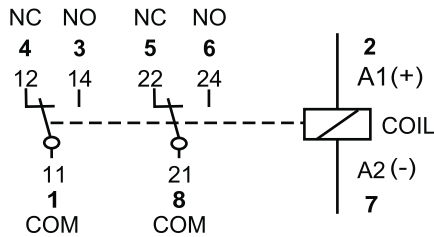

Graph 1 Electrical life, ops x 10⁶

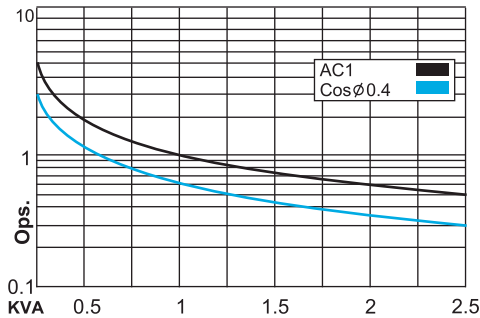

Graph 2 Max. DC load

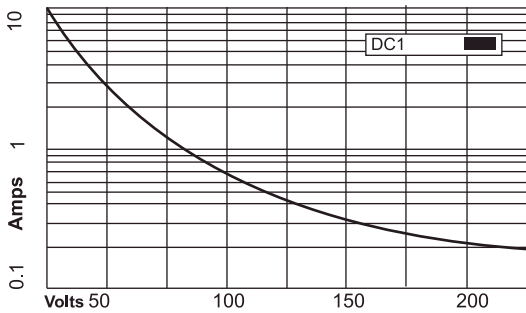

Dimensions in mm.

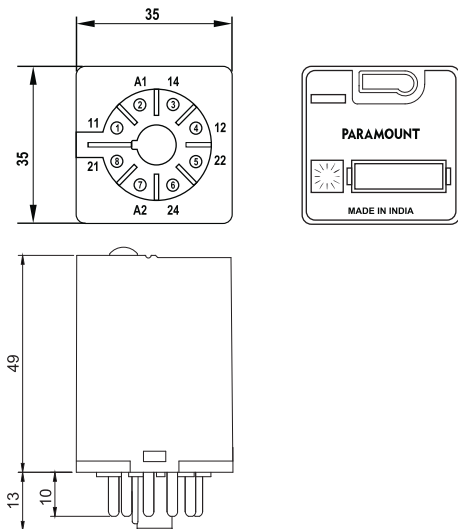

Contacts

Materials : Standard AgNi
Optional 1 AgNi + Au 0.2 μ
Optional 2 AgNi + Au 5.0 μ
Max. Switching Current 6A
Max. Peak Inrush Current (20 ms) 15A
Max. Switching Voltage 250 VAC
Switching Power range 0.3 VA (W) to 2500 VAZ
Max. Contact Resistance 20m Ω
Max. AC Load (Table 1) 2.5 KVA
Max. DC Load (See Table 2) -

Coils (Ohms ± 10% @ 20°C)

Pull-in Voltage 0.8xUn
Drop-out Voltage 0.1xUn
Nominal Coil Power 1.6 VA (AC / 1.3 W (DC))

VAC	Ohms	VDC	Ohms
6	3.15	6	33
12	13.3	12	115
24	52	24	480
48	240	48	1850
110	1120	110	9000
230	5600	220	29000

Insulation

Dielectric Strength (1 minute) : open contacts 1500 VAC
Between adjacent poles 2000 VAC
Between contacts and coil 2500 VAC
Insulation Resistance @ 500VDC Min. 200 MΩ
Isolation, IEC 61810-5 2.5 KV / 3

Specifications

Operate / Release & Bounce Time Max. for DC 8+3 / 3.5+8 ms
Operate / Release & Bounce Time Max. for AC 9+8 / 12+16 ms
Mechanical Life ops. 10 Million AC, 20 Million DC relays
Electrical life at Nominal load ≥ 700,000 ops.
Operating Frequency at nominal load 1200 / hour
Shock Resistance AK : > 10g
Vibration Resistance 5g 10.....150 Hz
Mounting Direction any
Storage -40°C to +85°C
Ambient Operating Temperature -40°C to +55°C (for AC relay)
Ambient Operating Temperature -40°C to +70°C (for DC relay)
Protection Standard IP 40
Weight app. 80 g

Standard Types

AC : 6, 12, 24, 48, 110, 230
H = Long Life Relay
F = Mechanical Flag Indicator
P = LED Indicator
I = Lockable Push Button
R = RC Circuit
DC : 6, 12, 24, 48, 110, 220
F = Mechanical Flag Indicator
P = LED
I = Lockable Push Button
W = Free Wheeling Diode
Z = Polarity & Free Wheeling Diode
B = AC/DC Bridge Rectifier

P3N-2-F-E VAC
P3N-2-FP-E VAC
P3N-2-FPI-E VAC
P3N-2-FIR-E VAC
P3N-2-F-E VDC
P3N-2-FP-E VDC
P3N-2-FPI-E VDC
P3N-2-FPWI-E VDC
P3N-2-FPZI-E VDC
P3N-2-FPIB-E VDC

Suitable Sockets : S8D, S8LD

Approvals





P3N-2.....H



Long Life Relay 2C/O Contacts

10 A 250V AC1 0.5 A 110VDC1
10 A 30V DC1 0.2 A 220VDC1

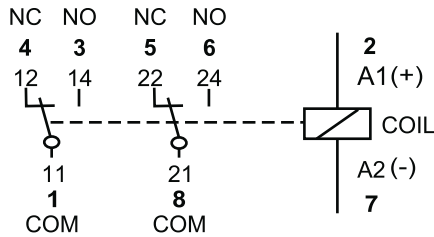

Graph 1 Electrical life, ops x 10⁶

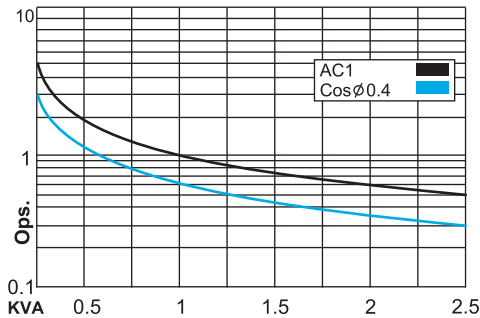

Graph 2 Max. DC load

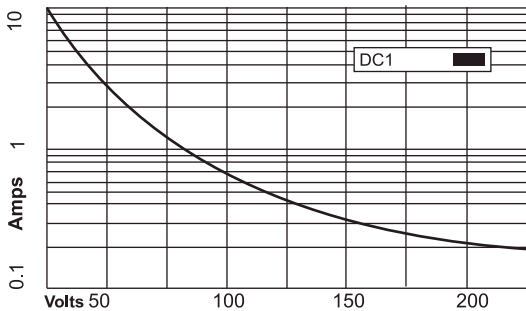

Dimensions in mm.

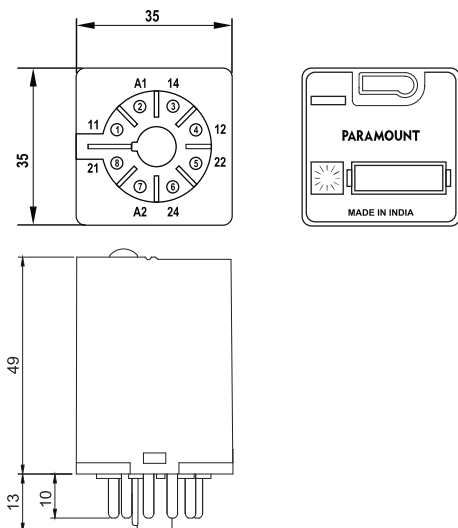

Contacts

Materials : Standard AgNi
Optional 1 AgNi + Au 0.2 μ
Optional 2 AgNi + Au 5.0 μ
Max. Switching Current 10A
Max. Peak Inrush Current (20 ms) 30A
Max. Switching Voltage 250 VAC
Switching Power range 0.3 VA (W) to 2500 VAZ
Max. Contact Resistance 20m Ω
Max. AC Load (Table 1) 2.5 KVA
Max. DC Load (See Table 2) -

Coils (Ohms ± 10% @ 20°C)

Pull-in Voltage 0.8xUn
Drop-out Voltage 0.1xUn
Nominal Coil Power 1.6 VA (AC / 1.3 W (DC))

VAC	Ohms	VDC	Ohms
6	3.15	6	33
12	13.3	12	115
24	52	24	480
48	240	48	1850
110	1120	110	9000
230	5600	220	29000

Insulation

Dielectric Strength (1 minute) : open contacts 1500 VAC
Between adjacent poles 2000 VAC
Between contacts and coil 2500 VAC
Insulation Resistance @ 500VDC Min. 200 MΩ
Isolation, IEC 61810-5 2.5 KV / 3

Specifications

Operate / Release & Bounce Time Max. for DC 8+3 / 3.5+8 ms
Operate / Release & Bounce Time Max. for AC 9+8 / 12+16 ms
Mechanical Life ops. 10 Million AC, 20 Million DC relays
Electrical life at Nominal load ≥ 700,000 ops.
Operating Frequency at nominal load 1200 / hour
Shock Resistance AK : > 10g
Vibration Resistance 5g 10.....150 Hz
Mounting Direction any
Storage -40°C to +85°C
Ambient Operating Temperature -40°C to +55°C (for AC relay)
Ambient Operating Temperature -40°C to +70°C (for DC relay)
Protection Standard IP 40
Weight app. 80 g

Standard Types

AC : 6, 12, 24, 48, 110, 230

H = Long Life Relay
F = Mechanical Flag Indicator
P = LED Indicator
I = Lockable Push Button
R = RC Circuit

P3N-2-F-H VAC
P3N-2-FP-H VAC
P3N-2-FPI-H VAC
P3N-2-FIR-H VAC

DC : 6, 12, 24, 48, 110, 220

F = Mechanical Flag Indicator
P = LED
I = Lockable Push Button
W = Free Wheeling Diode
Z = Polarity & Free Wheeling Diode
B = AC/DC Bridge Rectifier

P3N-2-F-H VDC
P3N-2-FP-H VDC
P3N-2-FPI-H VDC
P3N-2-FPWI-H VDC
P3N-2-FPZI-H VDC
P3N-2-FPIB-H VDC

Suitable Sockets : S8D, S8LD

Approvals



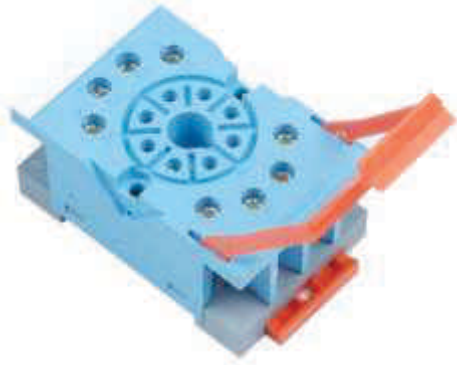

S8D

Only
38 mm
WIDE

**Socket Din Rail or Panel Mountable
for P3N-2 Relay**

Wiring diagram

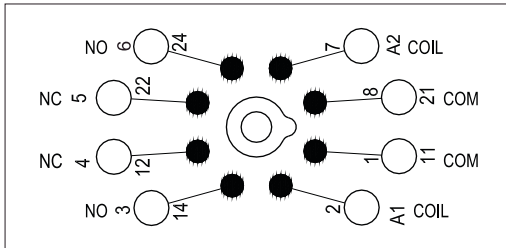

Specifications

Poles 2 Change Over Contact (8pins)
Nominal load : 10A / 250V

Insulation: Di-electric strength, 1minute

Between contact and coil	2.5 KV
Between all terminals and DIN Rail	2.5 KV
Between adjacent terminals	2.5 KV

Max. screw torque	0.5 Nm
Screw dimensions	M3, Pozi

Wire in-lets capacity:

Solid Wire	4sq mm or 2 x 2.25 mm
Multi core	22 14 AWG
Ferrule tip terminals	4mmsq

Weight Approx.	47 gms.
----------------	---------

Dimensions in mm

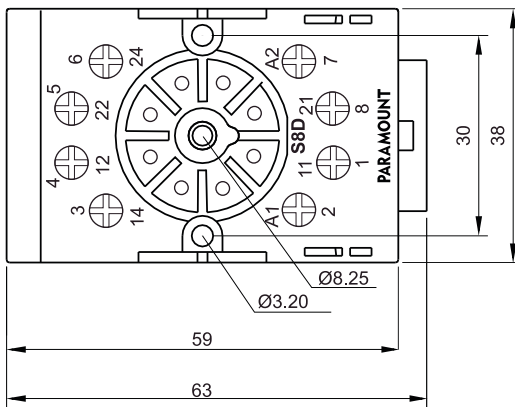
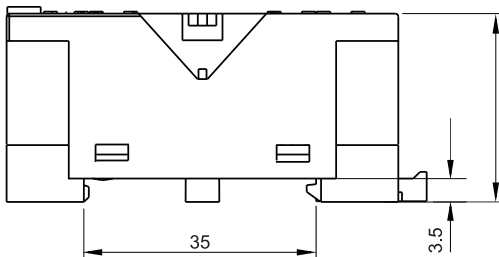

Other Aspects

- DIN Rail / Panel Mountable
- EN / DIN Sequential Numbering according to EN 60947 & IEC 61810
- Integrated Relay Hold Down Clip
- Removable White Marking Label
- Hard Brass Tin Plated Terminals
- Brass Tin Plated Screws

Suitable Relays : P3N-2, P3N-2M, P3N-2T

Approvals



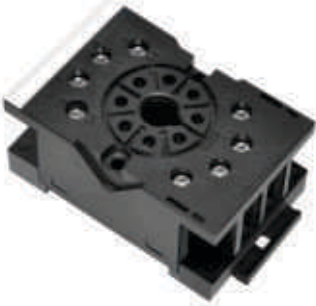

S8D-E

Only
38 mm
WIDE

**Socket Din Rail or Panel Mountable
for P3N-2 Relay**

Wiring diagram

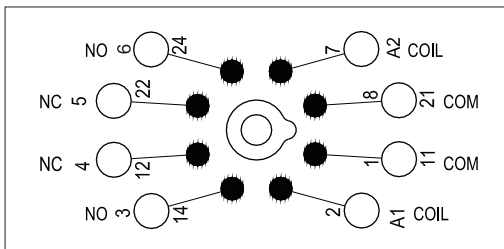

Specifications

Poles 2 Change Over Contact (8pins)
Nominal load : 10A / 250V

Insulation: Di-electric strength, 1minute

Between contact and coil	2.5 KV
Between all terminals and DIN Rail	2.5 KV
Between adjacent terminals	2.5 KV

Max. screw torque	0.5 Nm
Screw dimensions	M3, Pozi

Wire in-lets capacity:

Solid Wire	4sq mm or 2 x 2.25 mm
Multi core	22 14 AWG
Ferrule tip terminals	4mmsq

Weight Approx.	47 gms.
----------------	---------

Dimensions

in mm

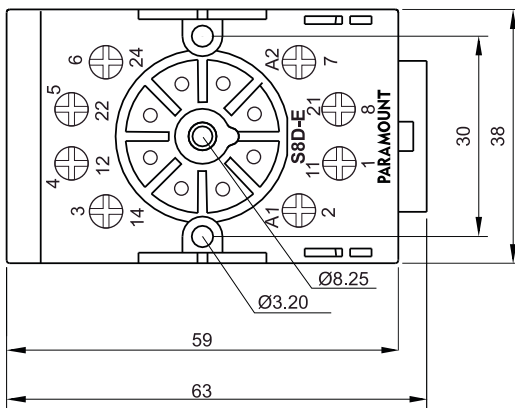
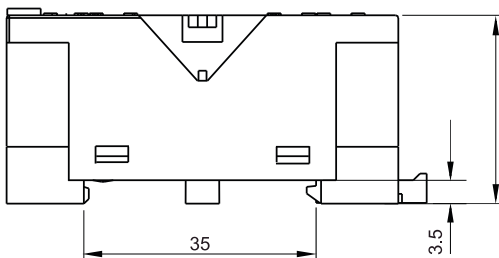

Other Aspects

- DIN Rail / Panel Mountable
- EN / DIN Sequential Numbering according to EN 60947 & IEC 61810
- Integrated Relay Hold Down Clip
- Removable White Marking Label
- Hard Brass Tin Plated Terminals
- Brass Tin Plated Screws

Suitable Relays : P3N-2-E1, P3N-2M-E1, P3N-2T-E1

Approvals



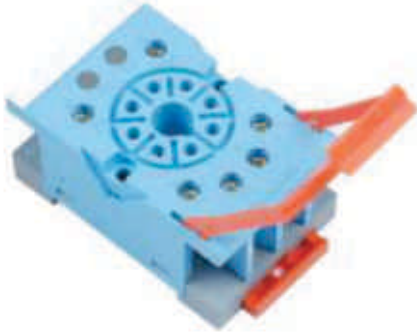

S8D-YA

Only
38 mm
WIDE

**Socket DIN Rail or Panel Mountable
for P3N-2 2N/O & 1NO Double Break Relays**

Wiring diagram

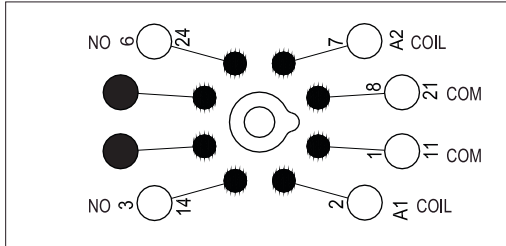

Specifications

Poles 2 N/O & 1NO Double Break Contact (8pins)
Nominal load : 10A / 250V

Insulation: Di-electric strength, 1minute

Between contact and coil	2.5 KV
Between all terminals and DIN Rail	2.5 KV
Between adjacent terminals	2.5 KV

Max. screw torque	0.5 Nm
Screw dimensions	M3, Pozi

Wire in-lets capacity:

Solid Wire	4sq mm or 2 x 2.25 mm
Multi core	22 14 AWG
Ferrule tip terminals	4mmsq

Weight Approx.	47 gms.
----------------	---------

Dimensions

in mm

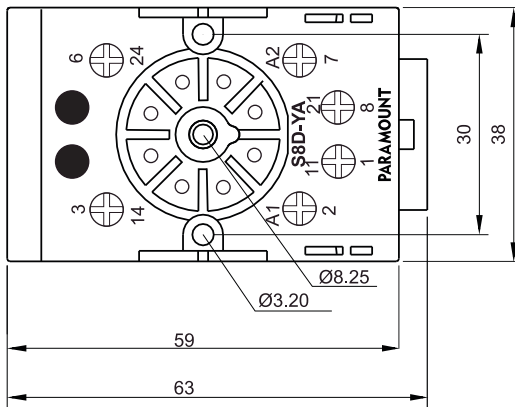
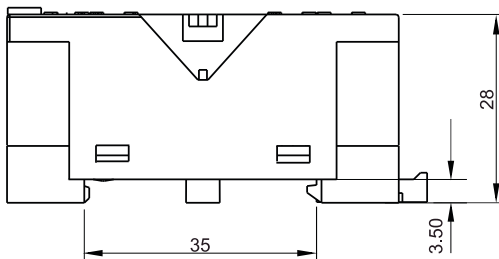

Other Aspects

DIN Rail / Panel Mountable
EN / DIN Sequential Numbering according to
EN 60947 & IEC 61810
Integrated Relay Hold Down Clip
Removable White Marking Label
Hard Brass Tin Plated Terminals
Brass Tin Plated Screws

Suitable Relays : P3N-2A, P3N-2A-M, P3N-YM

Approvals



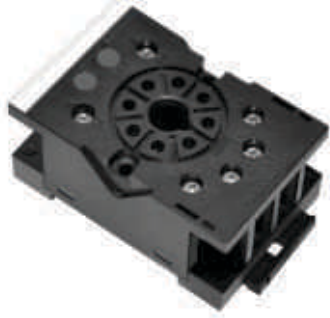

S8D-YA-E

Only
38 mm
WIDE

**Socket DIN Rail or Panel Mountable
for P3N-2 2N/O & 1NO Double Break Relays**

Wiring diagram

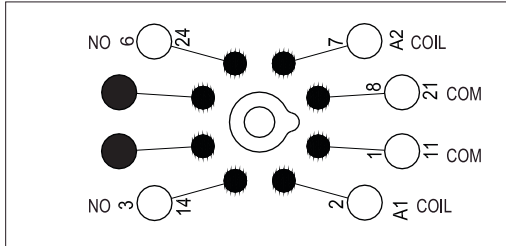

Specifications

Poles 2 N/O & 1NO Double Break Contact (8pins)
Nominal load : 10A / 250V

Insulation: Di-electric strength, 1minute

Between contact and coil	2.5 KV
Between all terminals and DIN Rail	2.5 KV
Between adjacent terminals	2.5 KV

Max. screw torque	0.5 Nm
Screw dimensions	M3, Pozi

Wire in-lets capacity:

Solid Wire	4sq mm or 2 x 2.25 mm
Multi core	22 14 AWG
Ferrule tip terminals	4mmsq

Weight Approx.	47 gms.
----------------	---------

Dimensions

in mm

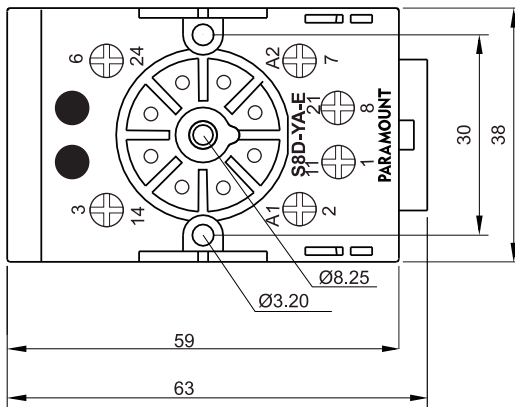
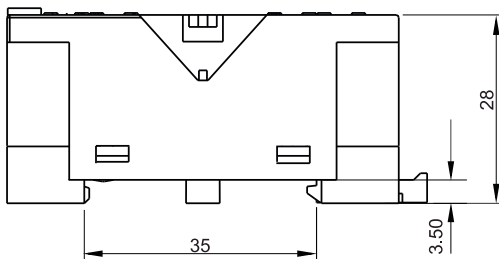

Other Aspects

DIN Rail / Panel Mountable
EN / DIN Sequential Numbering according to
EN 60947 & IEC 61810
Integrated Relay Hold Down Clip
Removable White Marking Label
Hard Brass Tin Plated Terminals
Brass Tin Plated Screws

Suitable Relays : P3N-2A-E1, P3N-2A-M-E1, P3N-YM-E1

Approvals



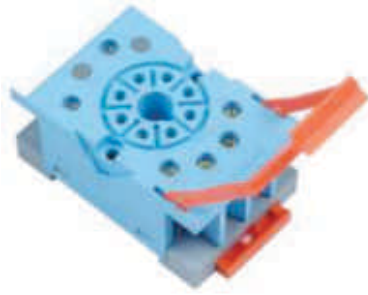

S8D-X

Only
38 mm
WIDE

**Socket DIN Rail or Panel Mountable
for P3N-X 1NO + 1NC Relay**

Wiring diagram

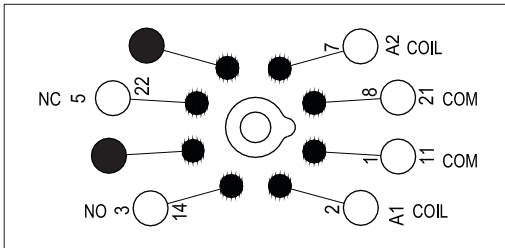

Specifications

Poles 1 NO + 1NC Contact (8pins)
Nominal load : 10A / 250V

Insulation: Di-electric strength, 1minute

Between contact and coil	2.5 KV
Between all terminals and DIN Rail	2.5 KV
Between adjacent terminals	2.5 KV

Max. screw torque	0.5 Nm
Screw dimensions	M3, Pozi

Wire in-lets capacity:

Solid Wire	4sq mm or 2 x 2.25 mm
Multi core	22 14 AWG
Ferrule tip terminals	4mmsq

Weight Approx.	47 gms.
----------------	---------

Dimensions

in mm

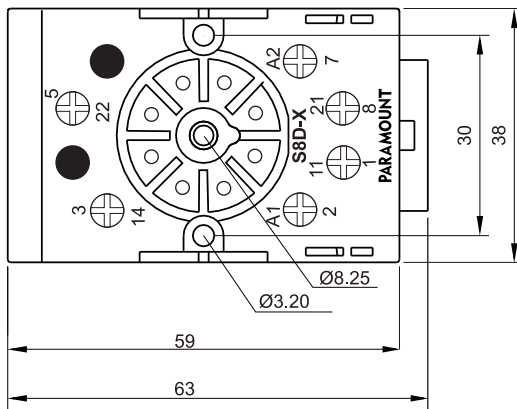
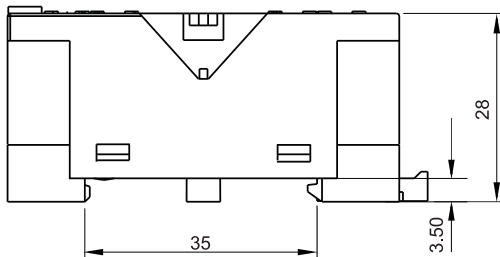

Other Aspects

DIN Rail / Panel Mountable
EN / DIN Sequential Numbering according to
EN 60947 & IEC 61810
Integrated Relay Hold Down Clip
Removable White Marking Label
Hard Brass Tin Plated Terminals
Brass Tin Plated Screws

Suitable Relays : P3N-X, P3N-XM

Approvals



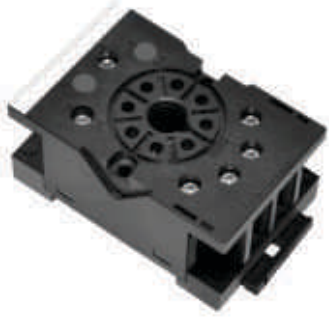

S8D-X-E

Only
38 mm
WIDE

**Socket DIN Rail or Panel Mountable
for P3N-X 1NO + 1NC Relay**

Wiring diagram

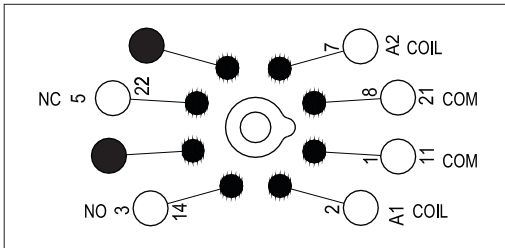

Specifications

Poles 1 NO + 1NC Contact (8pins)
Nominal load : 10A / 250V

Insulation: Di-electric strength, 1minute

Between contact and coil	2.5 KV
Between all terminals and DIN Rail	2.5 KV
Between adjacent terminals	2.5 KV

Max. screw torque	0.5 Nm
Screw dimensions	M3, Pozi

Wire in-lets capacity:

Solid Wire	4sq mm or 2 x 2.25 mm
Multi core	22 14 AWG
Ferrule tip terminals	4mmsq

Weight Approx.	47 gms.
----------------	---------

Dimensions

in mm

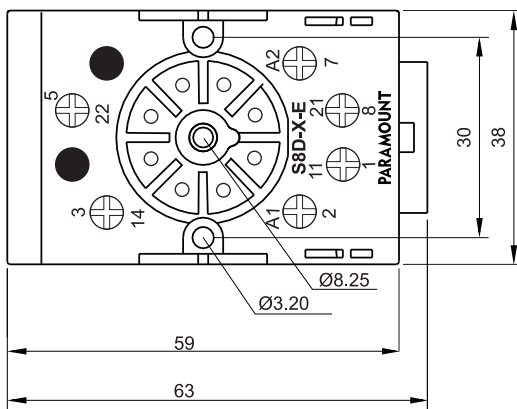
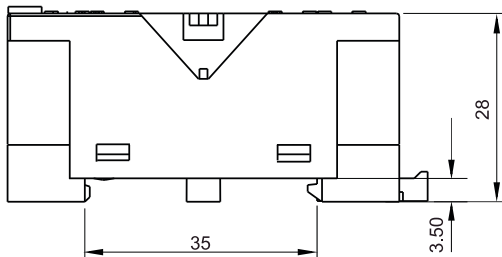

Other Aspects

DIN Rail / Panel Mountable
EN / DIN Sequential Numbering according to
EN 60947 & IEC 61810
Integrated Relay Hold Down Clip
Removable White Marking Label
Hard Brass Tin Plated Terminals
Brass Tin Plated Screws

Suitable Relays : P3N-X-E1, P3N-XM-E1

Approvals





S8LD

Only
38 mm
WIDE

**Socket Din Rail or Panel Mountable
for P3N-2 Relay**

Wiring diagram

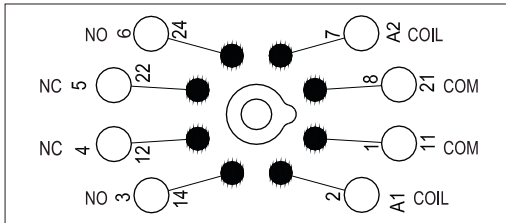

Dimensions in mm

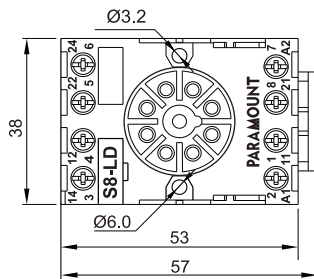
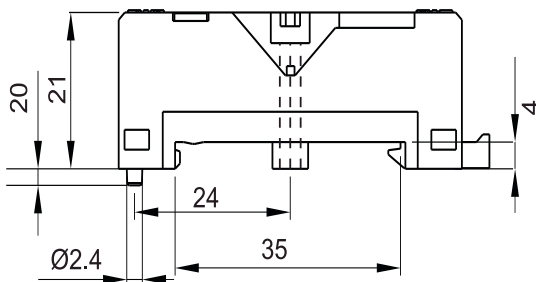

Accessories



S8LD-B1



C Terminal

Dimensions in mm.

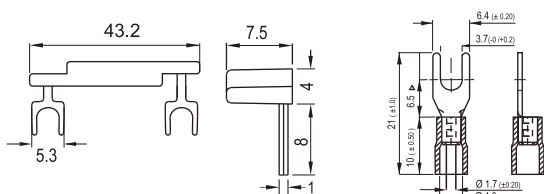

S8LD-B1
1 Way Bridge for Coil

Fork / C type crimped Terminal
used for wire connection

Specifications

Poles: 2 Change Over Contact (8pins)
Nominal load : 10A / 250V

Insulation: Di-electric strength, 1minute

Between contact and coil	2.5 KV
Between all terminals and DIN Rail	2.5 KV
Between adjacent terminals	2.5 KV

Max. screw torque	0.5 Nm
Screw dimensions	M3, Pozi
Weight Approx.	47 gms.

Other Aspects

DIN Rail / Panel Mountable
EN / DIN Sequential Numbering according to
EN 60947 & IEC 61810
Integrated Relay Hold Down Clip
Removable White Marking Label

Accessories

S8LD-B1 - 1 Way Bridge

Fork / C - Terminal for wire connection

Suitable Relays : P3N-2, P3N-2M, P3N-2T

Approvals





S8LD-E

Only
38 mm
WIDE

**Socket Din Rail or Panel Mountable
for P3N-2 Relay**

Wiring diagram

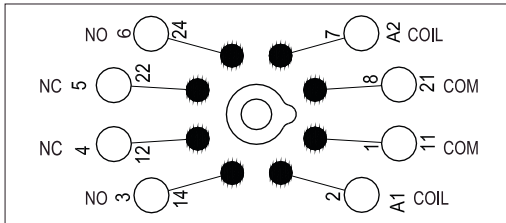

Dimensions in mm

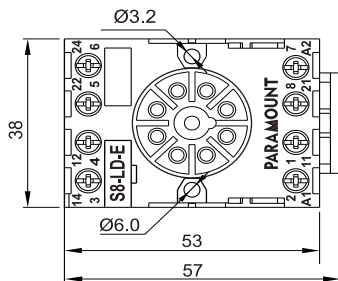
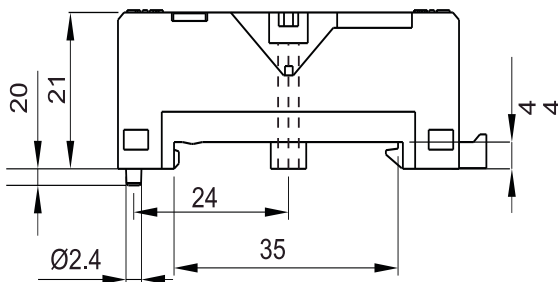

Accessories



S8LD-B1



C Terminal

Dimensions in mm.

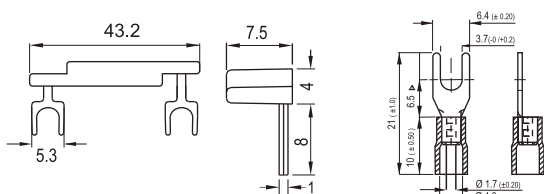

S8LD-B1
1 Way Bridge for Coil

Fork / C type crimped Terminal
used for wire connection

Specifications

Poles: 2 Change Over Contact (8pins)
Nominal load: 10A / 250V

Insulation: Di-electric strength, 1minute

Between contact and coil	2.5 KV
Between all terminals and DIN Rail	2.5 KV
Between adjacent terminals	2.5 KV

Max. screw torque	0.5 Nm
Screw dimensions	M3, Pozi
Weight Approx.	47 gms.

Other Aspects

DIN Rail / Panel Mountable
EN / DIN Sequential Numbering according to
EN 60947 & IEC 61810
Integrated Relay Hold Down Clip
Removable White Marking Label

Accessories

S8LD-B1 - 1 Way Bridge

Fork / C - Terminal for wire connection

Suitable Relays : P3N-2-E1, P3N-2M-E1, P3N-2T-E1

Approvals



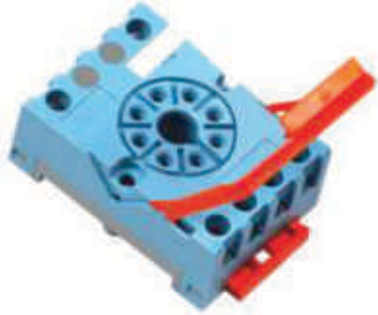

S8LD-YA

Only
38 mm
WIDE

**Socket DIN Rail or Panel Mountable
for P3N-2 2N/O & 1NO Double Break Relays**

Wiring diagram

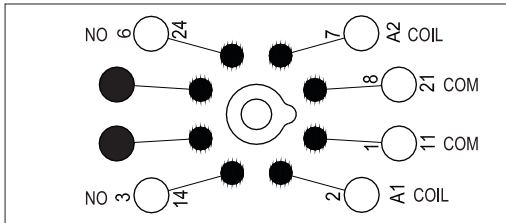

Dimensions in mm

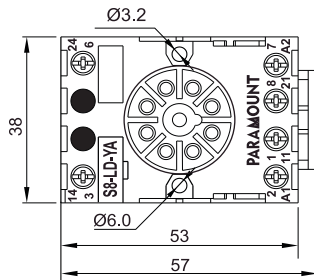
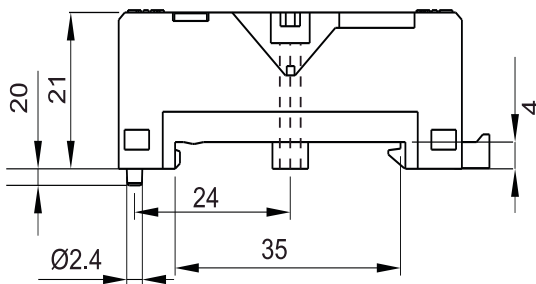

Specifications

Poles 2 N/O & 1NO Double Break Contact (8pins)
Nominal load : 10A / 250V

Insulation: Di-electric strength, 1minute

Between contact and coil	2.5 KV
Between all terminals and DIN Rail	2.5 KV
Between adjacent terminals	2.5 KV

Max. screw torque	0.5 Nm
Screw dimensions	M3, Pozi
Weight Approx.	47 gms.

Other Aspects

DIN Rail / Panel Mountable
EN / DIN Sequential Numbering according to
EN 60947 & IEC 61810
Integrated Relay Hold Down Clip
Removable White Marking Label

Accessories



S8LD-B1



C Terminal

Accessories

S8LD-B1 - 1 Way Bridge

Fork / C - Terminal for wire connection

Dimensions in mm.

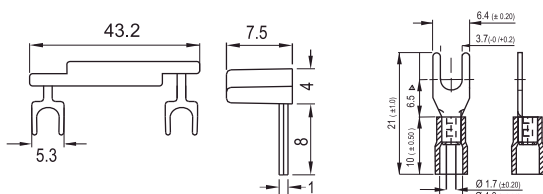

S8LD-B1
1 Way Bridge for Coil

Fork / C type crimped Terminal
used for wire connection

Suitable Relays : P3N-2A, P3N-YM

Approvals





S8LD-YA-E

Only
38 mm
WIDE

**Socket DIN Rail or Panel Mountable
for P3N-2 2N/O & 1NO Double Break Relays**

Wiring diagram

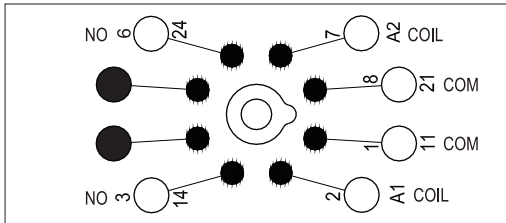

Dimensions in mm

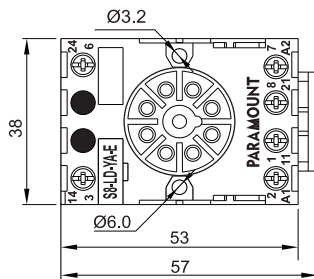
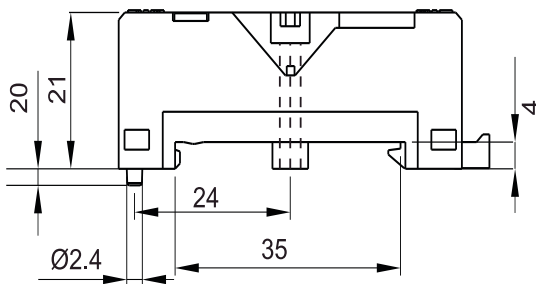

Specifications

Poles 2 N/O & 1NO Double Break Contact (8pins)
Nominal load : 10A / 250V

Insulation: Di-electric strength, 1minute

Between contact and coil	2.5 KV
Between all terminals and DIN Rail	2.5 KV
Between adjacent terminals	2.5 KV

Max. screw torque	0.5 Nm
Screw dimensions	M3, Pozi
Weight Approx.	47 gms.

Other Aspects

DIN Rail / Panel Mountable
EN / DIN Sequential Numbering according to
EN 60947 & IEC 61810
Integrated Relay Hold Down Clip
Removable White Marking Label

Accessories



S8LD-B1



C Terminal

Accessories

S8LD-B1 - 1 Way Bridge

Fork / C - Terminal for wire connection

Dimensions in mm.

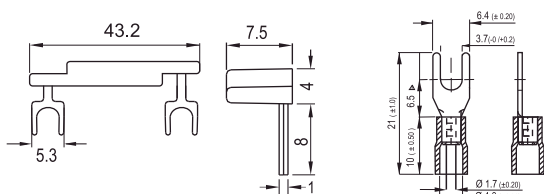

S8LD-B1
1 Way Bridge for Coil

Fork / C type crimped Terminal
used for wire connection

Suitable Relays : P3N-2A-E1, P3N-YM-E1

Approvals





S8LD-X-E

Only
38 mm
WIDE

**Socket DIN Rail or Panel Mountable
for P3N-X 1NO + 1NC Relay**

Wiring diagram

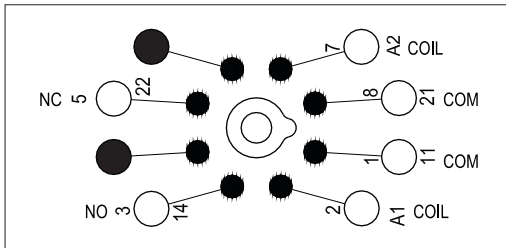

Dimensions in mm

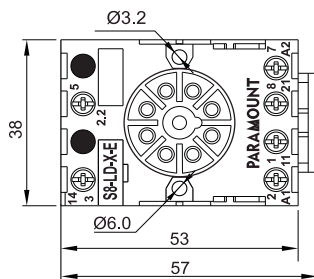
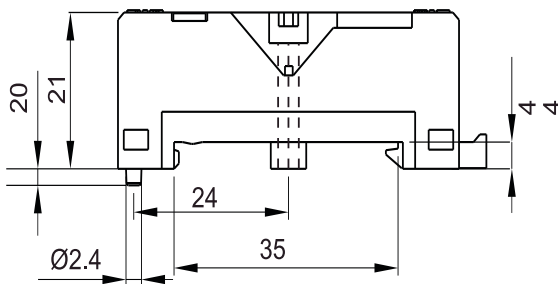

Accessories



S8LD-B1



C Terminal

Dimensions in mm.

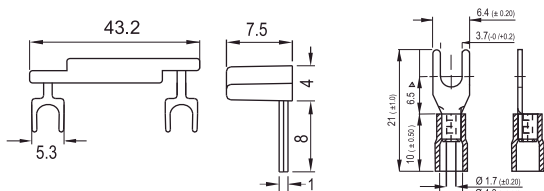

S8LD-B1
1 Way Bridge for Coil

Fork / C type crimped Terminal
used for wire connection

Specifications

Poles 1 NO + 1NC Contact (8pins)
Nominal load : 10A / 250V

Insulation: Di-electric strength, 1minute

Between contact and coil	2.5 KV
Between all terminals and DIN Rail	2.5 KV
Between adjacent terminals	2.5 KV

Max. screw torque 0.5 Nm

Screw dimensions M3, Pozi

Weight Approx. 47 gms.

Other Aspects

DIN Rail / Panel Mountable
EN / DIN Sequential Numbering according to
EN 60947 & IEC 61810
Integrated Relay Hold Down Clip
Removable White Marking Label

Accessories

S8LD-B1 - 1 Way Bridge

Fork / C - Terminal for wire connection

Suitable Relays : P3N-X-E1, P3N-XM-E1

Approvals



Ordering Information

P3N--------

1 2 3 4 5 6 7 8

1. Relay Type

Blank : General Purpose 2 Pole Relay / Standard

2. Contact Form

2 : DPT (2C/O)
2A : 2 NO
X : 1 NO + 1 NC &
Y : 1 NO Double Break

3. Contact Type

Blank : Single
T : Twin Contact

4. Features

F : Mechanical operation Indicator
P : LED Indicator
Z : Free Wheeling + Polarity Diode
I : Lockable Push Button & Manual Push Button
B : Bridge Rectifier
R : RC circuit
W : Free Wheeling Diode
S : Sensitive Relays

5. Special Types

Blank : Standard
M : Magnetic Blow Out
H : Long Life (700,000 operations)
N : Magnetic Blow Out High Rating

6. Contact Material

Blank : AgNi
1. : AgNi + Au 0.2 μ
2. : AgNi + Au 5.0 μ

7. Blank : UL Approved (10 Amps)

E : UL Approved (6 Amps)
E1 : NON UL (10 Amps)
E2 : NON UL (6 Amps)

8. Rated Coil Voltage

6 / 12 / 24 / 48 / 110 / 220 - VDC
6 / 12 / 24 / 48 / 115 / 230 - VAC

NOTE:-

- A. For Current coil please specify AC/DC coil current in place of coil voltage
- B. Standard Frequency is 50 Hz for AC coil, for other frequency please specify frequency after coil voltage

Ordering Information for Sockets for P3N-2 Relays

S8D	Din Rail Mountable Socket	(UL Approved)	For General purpose 2 CO Relays
S8LD	Din Rail Mountable Socket	(UL Approved)	For General purpose 2 CO Relays
S8D-X	Din Rail Mountable Socket	(UL Approved)	For General purpose 1 NO 1 NC Relays
S8LD-X	Din Rail Mountable Socket	(UL Approved)	For General purpose 1 NO 1 NC Relays
S8D-YA	Din Rail Mountable Socket	(UL Approved)	For General purpose 2 NO & 1NO Double Break Relays
S8LD-YA	Din Rail Mountable Socket	(UL Approved)	For General purpose 2 NO & 1NO Double Break Relays
S8D-E	Din Rail Mountable Socket	(NON UL)	For General purpose 2 CO Relays
S8LD-E	Din Rail Mountable Socket	(NON UL)	For General purpose 2 CO Relays
S8D-X-E	Din Rail Mountable Socket	(NON UL)	For General purpose 1 NO 1 NC Relays
S8LD-X-E	Din Rail Mountable Socket	(NON UL)	For General purpose 1 NO 1 NC Relays
S8D-YA-E	Din Rail Mountable Socket	(NON UL)	For General purpose 2 NO & 1NO Double Break Relays
S8LD-YA-E	Din Rail Mountable Socket	(NON UL)	For General purpose 2 NO & 1NO Double Break Relays