

**Catalogue
Series P6**

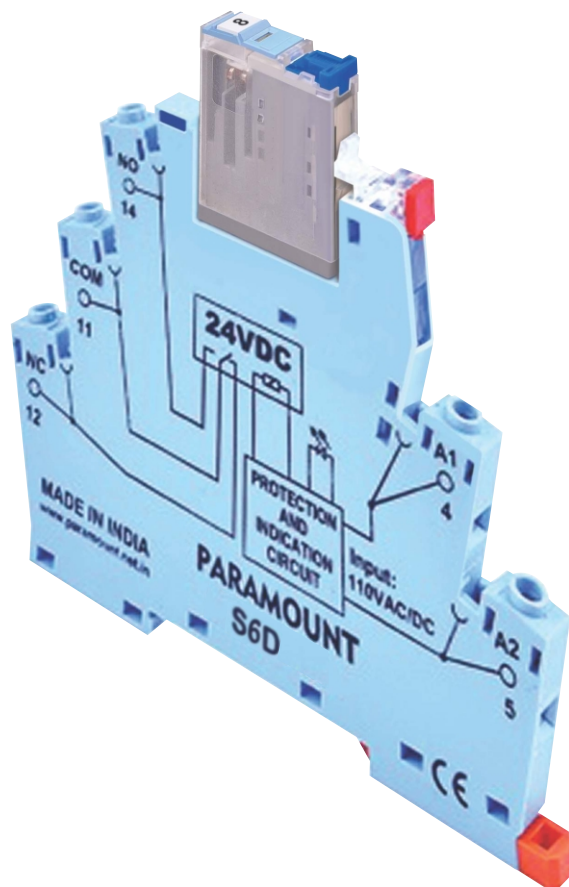



P6

One Pole, Change-Over Contact

8A 250V AC1 0.2A 220V DC1
8A 30V DC1 0.5A 110V DC1

Contacts

Materials : Standard AgNi
 Max. switching current 8 A
 Max. Peak inrush current (20 ms.) 15 A
 Max. Switching voltage 250 V
 Max. AC load (Graph 1) 2.5 KVA
 Max. DC load See Graph 2*

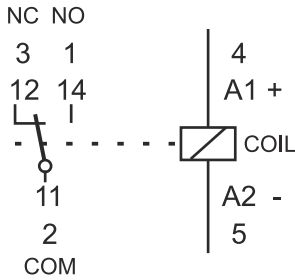

Graph 1 Electrical life, ops x 10⁶

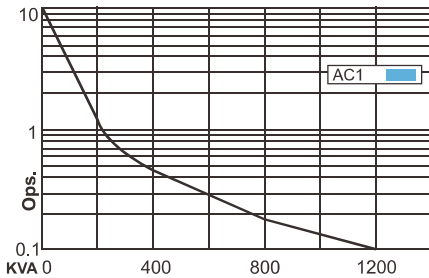

Graph 2 Max. DC load

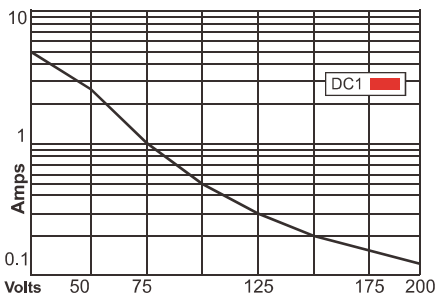

Dimensions in mm.

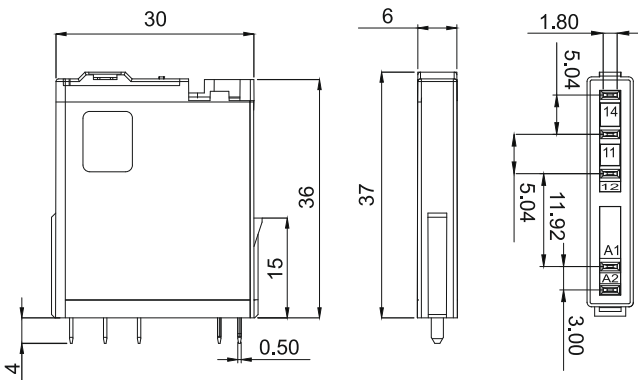

Coils (Ohms ± 10% @ 20°C)

Pull-in voltage ≤ 0.8 x Un
 Drop-out voltage ≥ 0.1 x Un
 Nominal Coil Power 1.1 VA (AC) / 0.7 W (DC)

VDC	ohms
24	1100

Insulation

Dielectric strength (1 minute):
 Open contacts 1 KV
 Between Contacts & Coil 8 KV
 Insulation resistance at 500VDC >3GΩ
 Isolation, IEC 61810-5: 4 KV / 3

Specifications

Operate Time + Bounce Time 10 ms.
 Release Time + Bounce Time 8 ms.
 Ambient Temperature -40°C (no ice)... +70°C
 Mechanical life ops. 10 Million AC, 20 Million DC relays
 Electrical life at nominal load > 100,000 ops.
 Operating frequency at nominal load 1,200 / hour
 Protection (Graph 1) IP40 / RT1
 Weight Approx. 21 gms.

Standard types

DC : 24 VDC

P6-24 DC

Suitable Sockets : S6D

Approvals

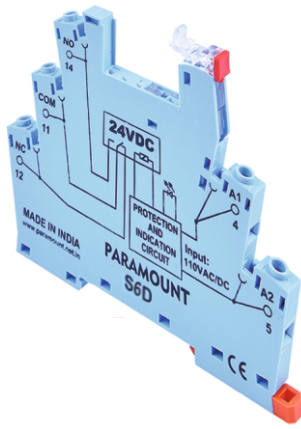

S6D

Only
6 mm
WIDE

**Input / Output Slim Sockets (8A)
for 1CO Slim Relays DIN Rail Mountable
8 A 230V AC1**

Wiring Diagram

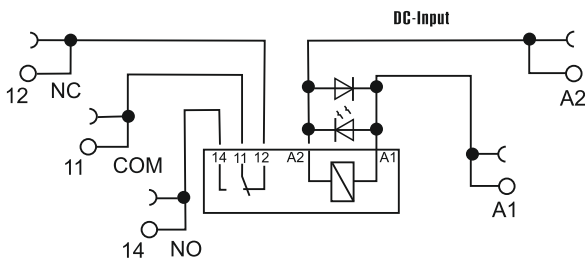

Socket Dimension

in mm

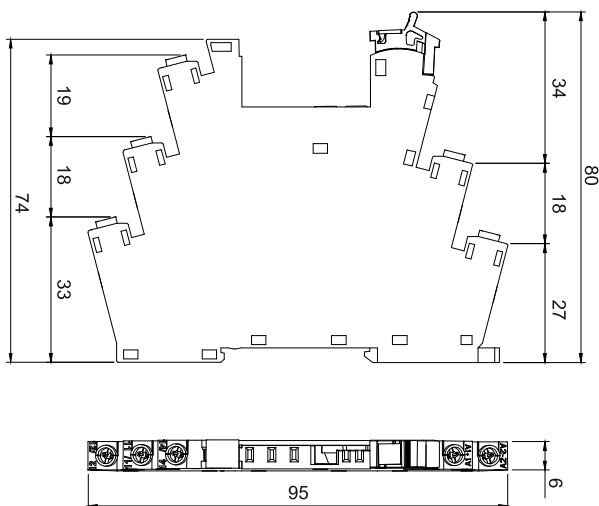

Other Aspects

Weight Approx. 25 gms

DIN Rail

Removable White Marking Label

EN / DIN Sequential Numbering according to

EN 60947 & IEC 61810

Specifications

No. of Poles	1
Output Contact Rating (Relay)	8A @ 250VAC / 24VDC
Insulation : Dielectric Strength , 1 minute	
Between all terminals and DIN Rail	5 KV
Brass TIN plated Screw	Yes
Max. Screw Torque	0.6 Nm
Screw Dimensions	7mm

Wire In-lets Capacity

Suitable Relays :

P6 24VDC

Ordering Information

24VAC / DC	S6D
110VAC / DC	S6D-1
230VAC / DC	S6D-2

Paramount Industries

70, 5th Cross, SSI Area, Rajajinagar,
Bangalore - 560 010, India.

Email : info@paramount.net.in

Website : www.paramount.net.in

Specification may change in the view of product improvement without prior intimation.

