

Catalogue

Series P3 2C/O Relay

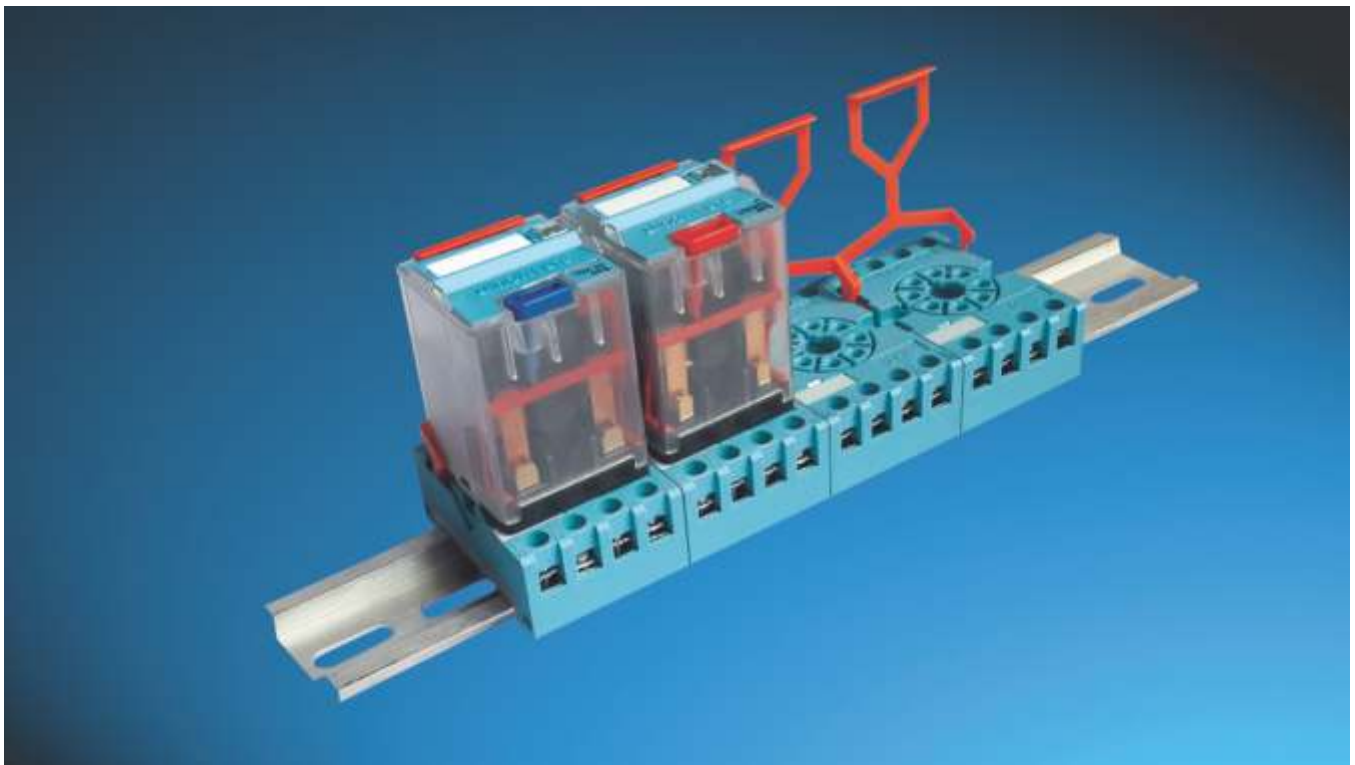

Benefits
of the new **Plus** system

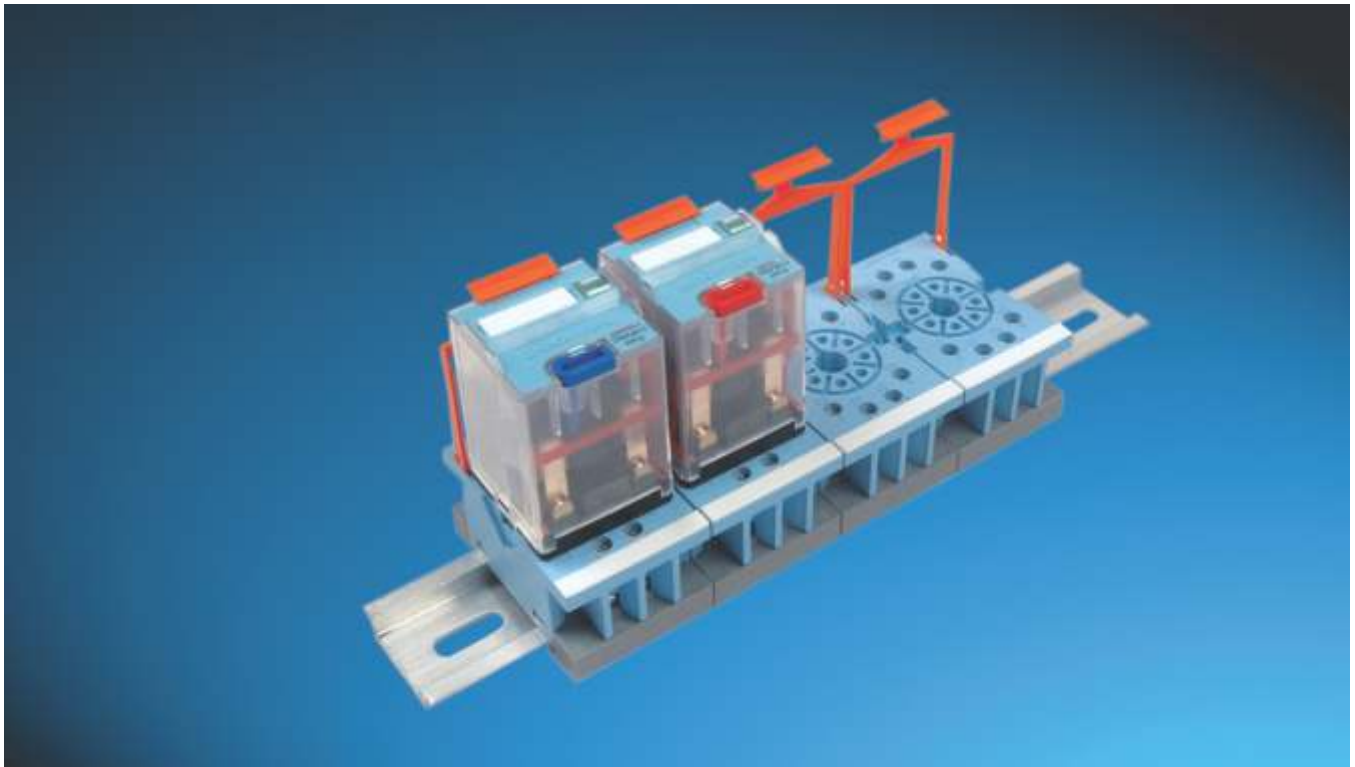
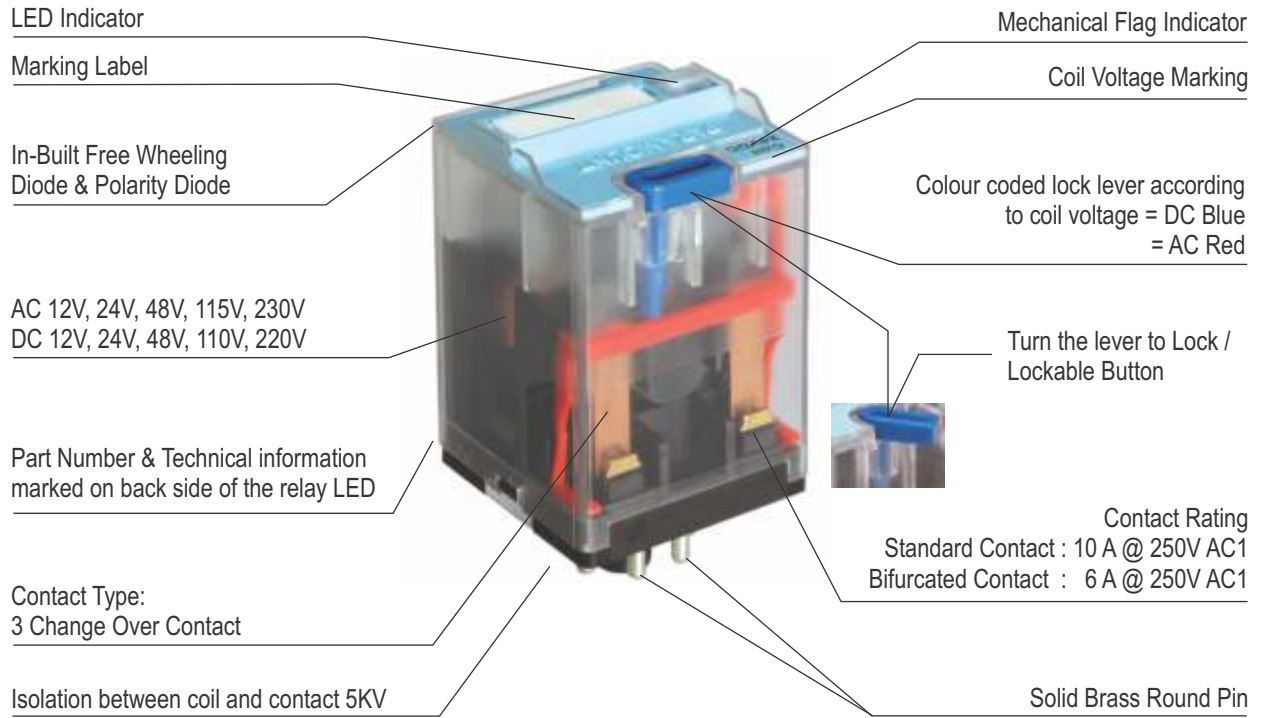

P3 is a Two & Three Pole Industrial Plug In Relay with all the In-built Mechanical and Electronic Features.

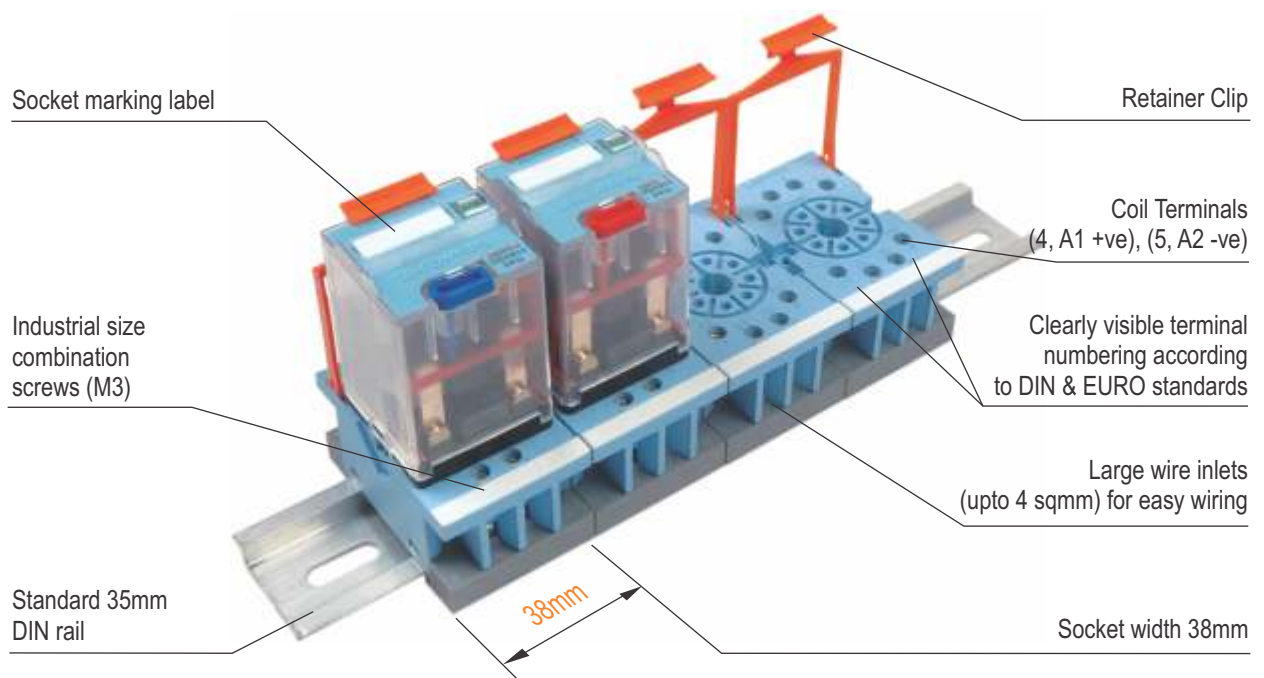

S8D & S11D is a Two Pole & Three Pole Touch protected Interface Socket.

Benefits
of the new

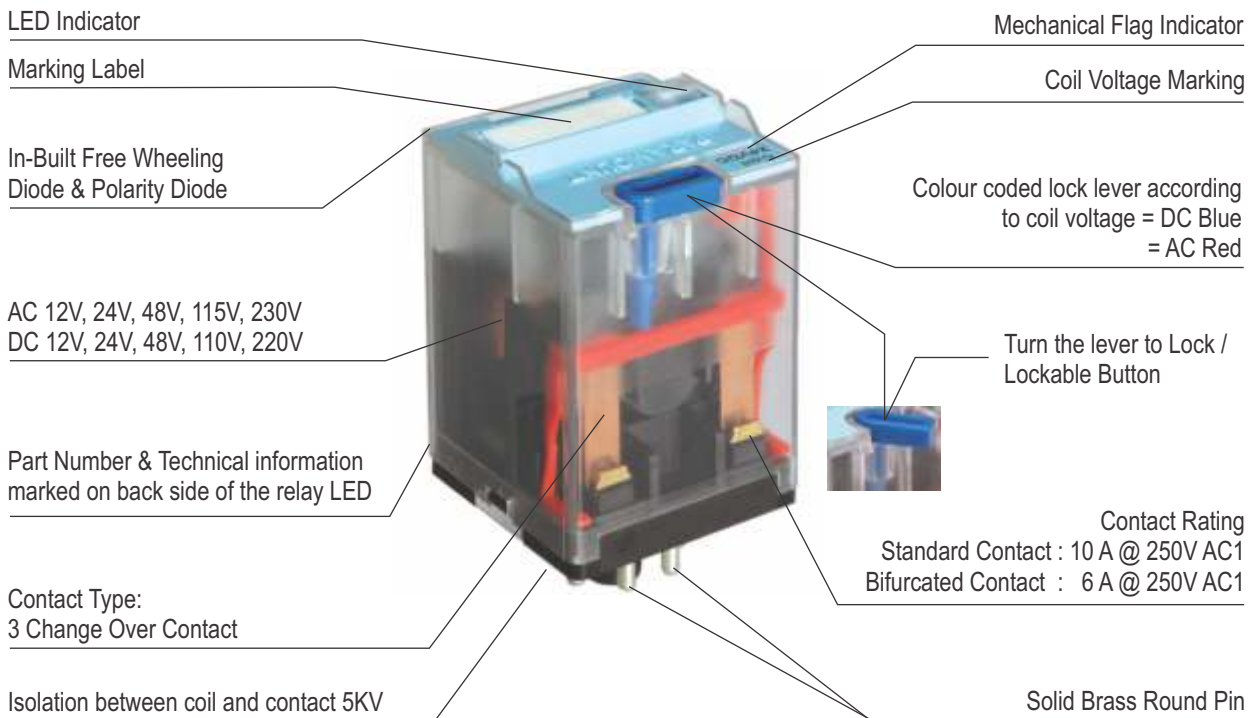

P3 is a Two & Three Pole Industrial Plug In Relay with all the In-built Mechanical and Electronic Features.

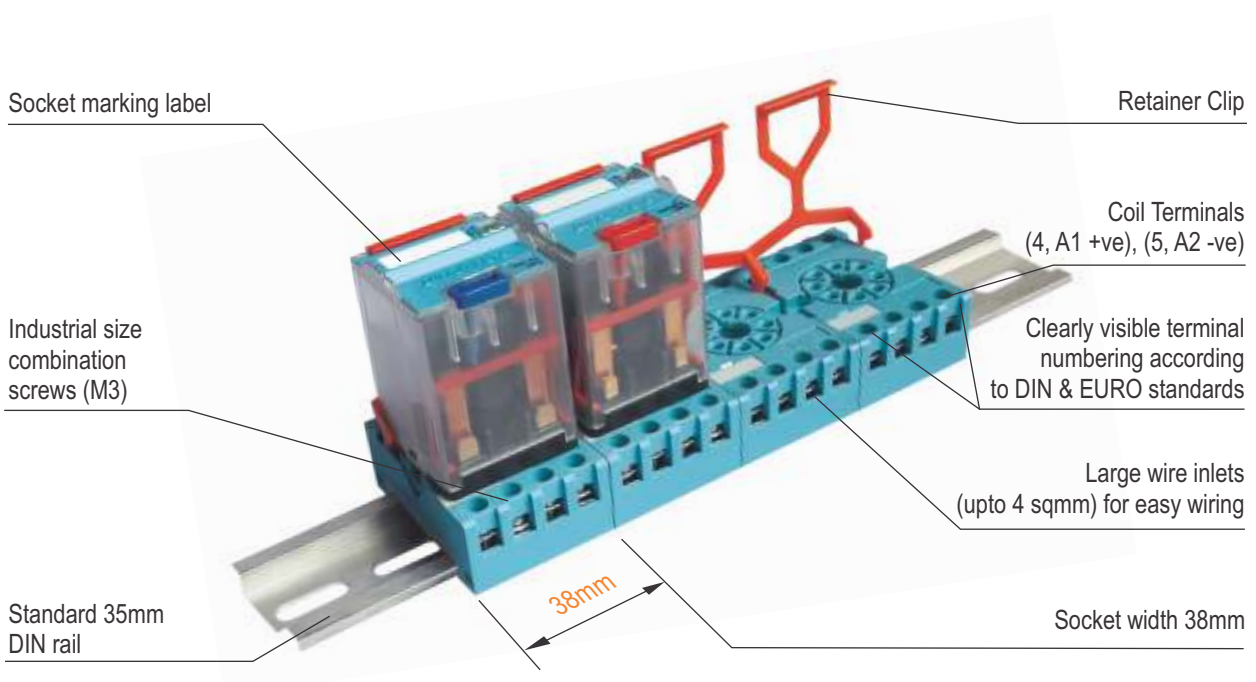

S8D & S11D is a Two Pole & Three Pole Touch protected Interface Socket.



P3-2



General Purpose 2 C/O Contacts
10 A 250V AC1 0.5 A 110V DC1
10 A 30V DC1 0.2 A 220V DC1

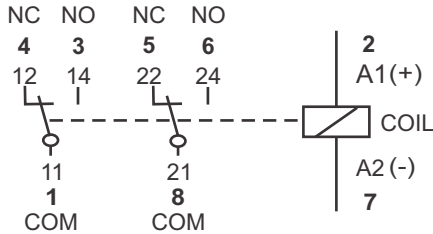

Contacts

Materials: Standard AgNi
 Optional 1 AgNi + Au 0.2 μ
 Optional 2 AgNi + Au 5.0 μ
 Max. Switching Current 10A
 Max. Peak Inrush Current (20 ms) 30A
 Max. Switching Voltage 250 VAC
 Switching Power range 0.3 VA (W) to 2500 VA
 Max. Contact Resistance 20m Ω
 Max. AC Load (Table 1) 2.5 KVA
 Max. DC Load (See Table 2) -

Coils (Ohms ± @ 20°C)

Pull-in Voltage ≤ 0.8xUn
 Drop-out Voltage ≥ 0.1xUn
 Nominal Coil Power 2.5 VA (AC / 1.3 W (DC))

VAC	Ohms	VDC	Ohms
6	3.15	6	33
12	13.3	12	115
24	52	24	480
48	240	48	1850
110	1120	110	9000
230	5600	220	29000

Graph 1 Electrical life, ops x 10⁶

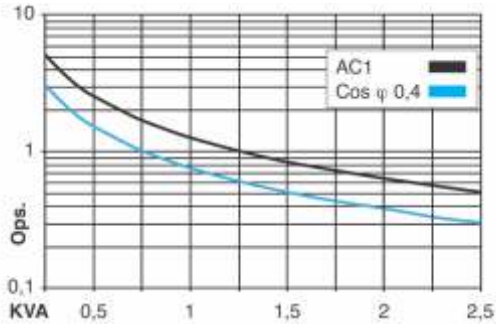

Graph 2 Max. DC load

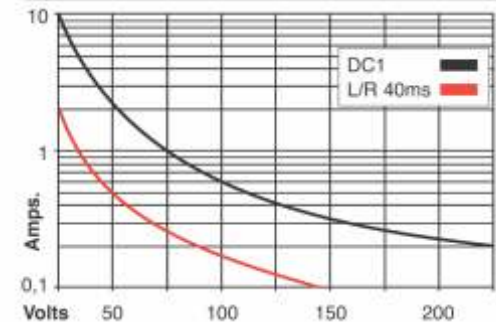

Dimensions in mm.

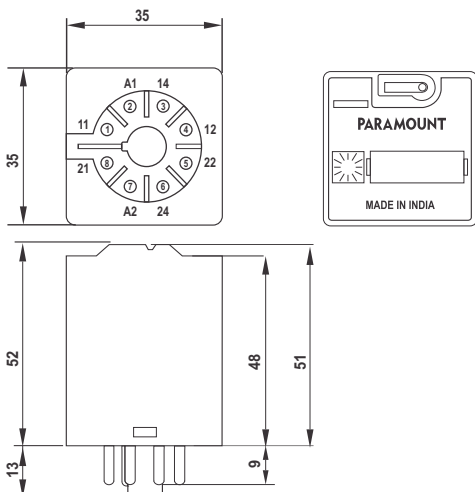

Insulation

Dielectric Strength (1 minute): open contacts 1500 VAC
 Between adjacent poles 2000 VAC
 Between contacts and coil 2500 VAC
 Insulation Resistance @ 500VDC Min. ≥ 200 MΩ
 Isolation, IEC 61810-5 2.5 KV / 3

Specifications

Operate / Release & Bounce Time Max. for DC +3 / 3.5+ ms
 Operate / Release & Bounce Time Max. for AC 9+8 / 12+16 ms
 Mechanical Life ops. 10 Million AC, 20 Million DC relays
 Electrical life at Nominal load ≥ 100,000 ops.
 Operating Frequency at nominal load 1200 / hour
 Shock Resistance AK : > 10g
 Vibration Resistance 5g 10.....150 Hz
 Mounting Direction any
 Storage -40°C to +85°C
 Ambient Operating Temperature -40°C to +55°C (for AC relay)
 Ambient Operating Temperature -40°C to +70°C (for DC relay)
 Protection Standard IP 40
 Weight app. 80 g

Standard Types

AC : 6, 12, 24, 48, 110, 230
 F = Mechanical Flag Indicator
 P = LED Indicator
 I = Lockable Push Button
 R = RC Circuit
DC : 6, 12, 24, 48, 110, 220
 F = Mechanical Flag Indicator
 P = LED
 I = Lockable Push Button
 W = Free Wheeling Diode
 Z = Polarity & Free Wheeling Diode
 B = AC/DC Bridge Rectifier

P3-2-F VAC
P3-2-FP VAC
P3-2-FPI VAC
P3-2-FIR VAC
P3-2-F VDC
P3-2-FP VDC
P3-2-FPI VDC
P3-2-FPIW VDC
P3-2-FPZI VDC
P3-2-FPIB VAD

Suitable Sockets : S8D, S8LD

Approvals





P3-2A

General Purpose 2 NO Contacts
10 A 250V AC1 0.7 A 110V DC1
10 A 30V DC1 0.4 A 220V DC1

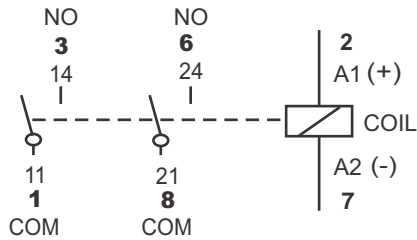

Graph 1 Electrical life, ops x 10⁶

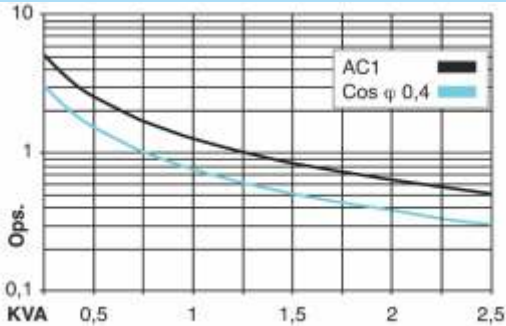

Graph 2 Max. DC load

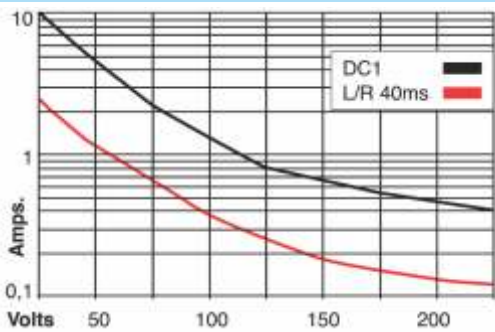

Dimensions in mm.

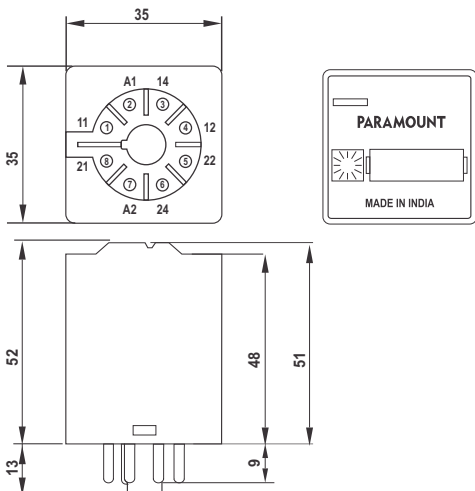

Contacts

Materials : Standard AgNi
 Optional 1 AgNi + Au 0.2 μ
 Optional 2 AgNi + Au 5.0 μ

Max. Switching Current 10A
 Max. Peak Inrush Current (20 ms) 30A
 Max. Switching Voltage 250 VAC
 Switching Power range 0.3 VA (W) to 2500 VA
 Max. Contact Resistance 20m Ω
 Max. AC Load (Table 1) 2.5 KVA
 Max. DC Load (See Table 2) -

Coils (Ohms ± @ 20°C)

Pull-in Voltage ≤ 0.8xUn
 Drop-out Voltage ≥ 0.1xUn
 Nominal Coil Power 1.6 VA (AC / 1.3 W (DC))

VAC	Ohms	VDC	Ohms
6	3.15	6	33
12	13.3	12	115
24	52	24	480
48	240	48	1850
110	1120	110	9000
230	5600	220	29000

Insulation

Dielectric Strength (1 minute) : open contacts 2000 VAC
 Between adjacent poles 2000 VAC
 Between contacts and coil 2500 VAC
 Insulation Resistance @ 500VDC Min. 200 MΩ
 Isolation, IEC 61810-5 2.5 KV / 3

Specifications

Operate / Release & Bounce Time Max. for DC 20+3 ms
 Operate / Release & Bounce Time Max. for AC 20+8 ms
 Mechanical Life ops. 10 Million AC, 20 Million DC relays
 Electrical life at Nominal load ≥ 100,000 ops.
 Operating Frequency at nominal load 1200 / hour
 Shock Resistance AK : > 10g
 Vibration Resistance 5g 10.....150 Hz
 Mounting Direction any
 Storage -40°C to +85°C
 Ambient Operating Temperature -40°C to +55°C (for AC relay)
 Ambient Operating Temperature -40°C to +70°C (for DC relay)
 Protection Standard IP 40
 Weight app. 80 g

Standard Types

AC : 6, 12, 24, 48, 110, 230
 F = Mechanical Flag Indicator
 P = LED Indicator
 R = RC Circuit

P3-2A-F VAC
P3-2A-FP VAC
P3-2A-FR VAC

DC : 6, 12, 24, 48, 110, 220
 F = Mechanical Flag Indicator
 P = LED
 W = Free Wheeling Diode
 Z = Polarity & Free Wheeling Diode
 B = AC/DC Bridge Rectifier

P3-2A-F VDC
P3-2A-FP VDC
P3-2A-FPW VDC
P3-2A-FPZ VDC
P3-2A-FPB VAD

Suitable Sockets : S8D-YA, S8LD-YA

Approvals





P3-X



General Purpose 1 NO + 1 NC Contacts
10 A 250V AC1 0.7 A 110V DC1
10 A 30V DC1 0.4 A 220V DC1

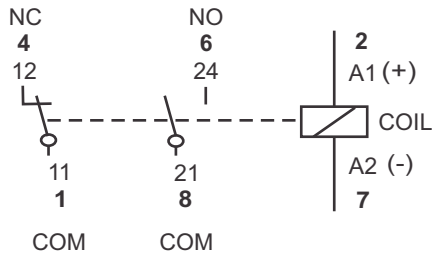

Contacts

Materials : Standard AgNi
 Optional 1 AgNi + Au 0.2 μ
 Optional 2 AgNi + Au 5.0 μ

Max. Switching Current 10A
 Max. Peak Inrush Current (20 ms) 30A
 Max. Switching Voltage 250 VAC
 Switching Power range 0.3 VA (W) to 2500 VAz
 Max. Contact Resistance 20m Ω
 Max. AC Load (Table 1) 2.5 KVA
 Max. DC Load (See Table 2) -

Coils (Ohms ± @ 20°C)

Pull-in Voltage ≤ 0.8xUn
 Drop-out Voltage ≥ 0.1xUn
 Nominal Coil Power 1.6 VA (AC / 1.3 W (DC))

VAC	Ohms	VDC	Ohms
6	3.15	6	33
12	13.3	12	115
24	52	24	480
48	240	48	1850
110	1120	110	9000
230	5600	220	29000

Graph 1 Electrical life, ops x 10⁶

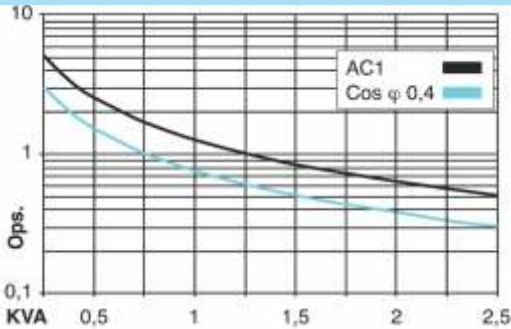

Graph 2 Max. DC load

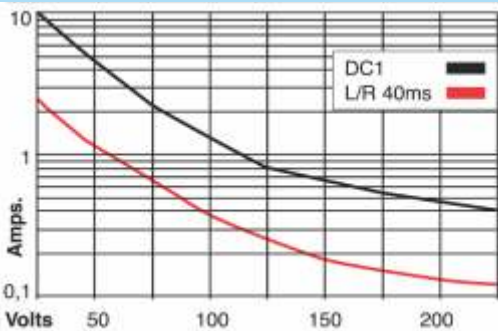

Dimensions in mm.

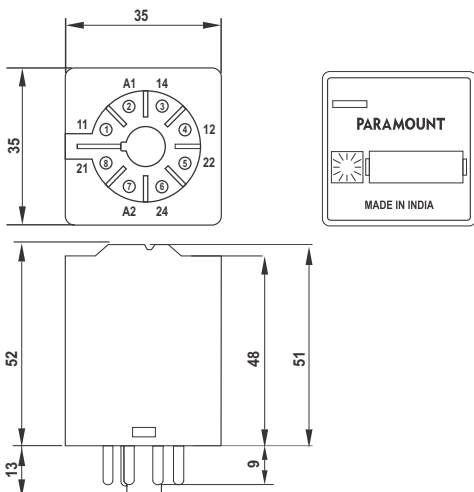

Insulation

Dielectric Strength (1 minute) : open contacts 2000 VAC
 Between adjacent poles 2000 VAC
 Between contacts and coil 2500 VAC
 Insulation Resistance @ 500VDC Min. 200 MΩ
 Isolation, IEC 61810-5 2.5 KV / 3

Specifications

Operate / Release & Bounce Time Max. for DC 20+3 ms
 Operate / Release & Bounce Time Max. for AC 20+8 ms
 Mechanical Life ops. 10 Million AC, 20 Million DC relays
 Electrical life at Nominal load ≥ 50 ,000 ops.
 Operating Frequency at nominal load 1200 / hour
 Shock Resistance AK : > 10g
 Vibration Resistance 5g 10.....150 Hz
 Mounting Direction any
 Storage -40°C to +85°C
 Ambient Operating Temperature -40°C to +55°C (for AC relay)
 Ambient Operating Temperature -40°C to +70°C (for DC relay)
 Protection Standard IP 40
 Weight app. 80 g

Standard Types

AC : 6, 12, 24, 48, 110, 230

F = Mechanical Flag Indicator

P = LED Indicator

R = RC Circuit

P3-X-F VAC

P3-X-FP VAC

P3-X-FR VAC

DC : 6, 12, 24, 48, 110, 220

F = Mechanical Flag Indicator

P = LED

W = Free Wheeling Diode

Z = Polarity & Free Wheeling Diode

B = AC/DC Bridge Rectifier

P3-X-F VDC

P3-X-FP VDC

P3-X-FPW VDC

P3-X-FPZ VDC

P3-X-FPB VAD

Suitable Sockets : S8D-X, S8LD-X

Approvals





P3-Y



General Purpose 1 NO Double Break
10 A 250V AC1 7.0 A 110V DC1
10 A 30V DC1 1.2 A 220V DC1

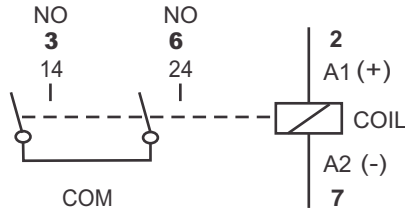

Contacts

Materials : Standard AgNi
 Optional 1 AgNi + Au 0.2 μ
 Optional 2 AgNi + Au 5.0 μ
 Max. Switching Current 10A
 Max. Peak Inrush Current (20 ms) 30A
 Max. Switching Voltage 250 VAC
 Switching Power range 0.3 VA (W) to 2500 VA
 Max. Contact Resistance 20m Ω
 Max. AC Load (Table 1) 2.5 KVA
 Max. DC Load (See Table 2) -

Coils (Ohms ± @ 20°C)

Pull-in Voltage ≤ 0.8 x Un
 Drop-out Voltage ≥ 0.1 x Un

Nominal Coil Power 1.6 VA (AC / 1.3 W (DC))

VAC	Ohms	VDC	Ohms
6	3.15	6	33
12	13.3	12	115
24	52	24	480
48	240	48	1850
110	1120	110	9000
230	5600	220	29000

Graph 1 Electrical life, ops x 10⁶

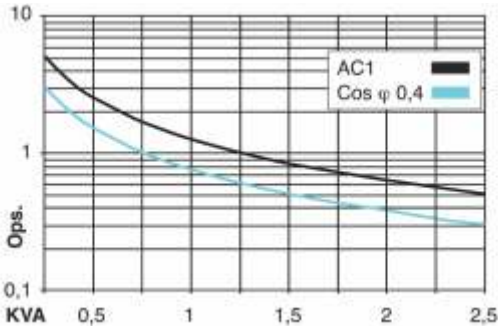

Graph 2 Max. DC load

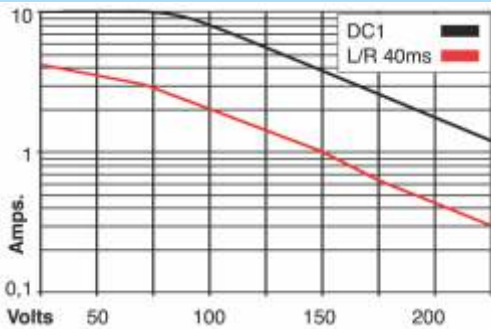

Dimensions in mm.

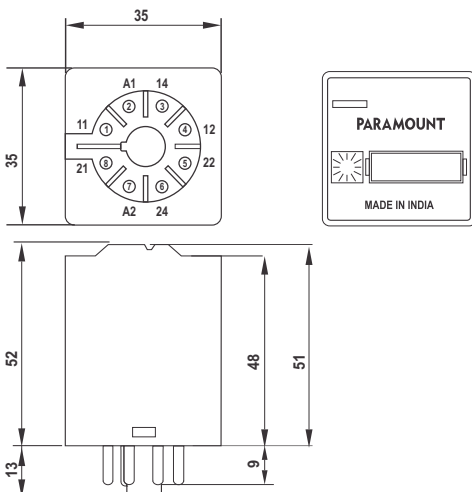

Insulation

Dielectric Strength (1 minute) : open contacts 2000 VAC
 Between adjacent poles 2000 VAC
 Between contacts and coil 2500 VAC
 Insulation Resistance @ 500VDC Min. 200 MΩ
 Isolation, IEC 61810-5 2.5 KV / 3

Specifications

Operate / Release & Bounce Time Max. for DC 20+3 ms
 Operate / Release & Bounce Time Max. for AC 20+8 ms
 Mechanical Life ops. 10 Million AC, 20 Million DC relays
 Electrical life at Nominal load ≥ 100,000 ops.
 Operating Frequency at nominal load 1200 / hour
 Shock Resistance AK : > 10g
 Vibration Resistance 5g 10.....150 Hz
 Mounting Direction any
 Storage -40°C to +85°C
 Ambient Operating Temperature -40°C to +55°C (for AC relay)
 Ambient Operating Temperature -40°C to +70°C (for DC relay)
 Protection Standard IP 40
 Weight app. 80 g

Standard Types

AC : 6, 12, 24, 48, 110, 230

F = Mechanical Flag Indicator

P = LED Indicator

R = RC Circuit

P3-Y-F VAC

P3-Y-FP VAC

P3-Y-FR VAC

DC : 6, 12, 24, 48, 110, 220

F = Mechanical Flag Indicator

P = LED

W = Free Wheeling Diode

Z = Polarity & Free Wheeling Diode

B = AC/DC Bridge Rectifier

P3-Y-F VDC

P3-Y-FP VDC

P3-Y-FPW VDC

P3-Y-FPZ VDC

P3-Y-FPB VAD

Suitable Sockets : S8D-YA, S8LD-YA

Approvals



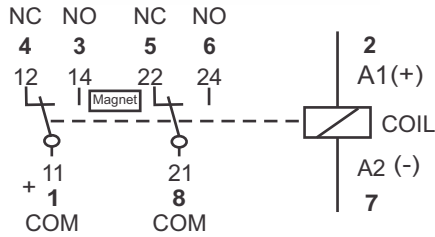

P3-2....M



Magnetic Blow Out 2 C/O Contacts

10 A 250V AC1 5 A 220V DC1
10 A 30V DC1 3 A 220V DC13

Contacts

Materials : Standard	AgNi
Optional 1	AgNi + Au 0.2 μ
Optional 2	AgNi + Au 5.0 μ
Max. Switching Current	10A
Max. Peak Inrush Current (20 ms)	30A
Max. Switching Voltage	250 VAC
Switching Power range	0.3 VA (W) to 2500 VA
Max. Contact Resistance	20m Ω
Max. AC Load (Table 1)	2.5 KVA

Coils (Ohms ± @ 20°C)

Pull-in Voltage	≤ 0.8xUn
Drop-out Voltage	≥ 0.1xUn

Nominal Coil Power 1.6 VA (AC / 1.3 W (DC))

VAC	Ohms	VDC	Ohms
6	3.15	6	33
12	13.3	12	115
24	52	24	480
48	240	48	1850
110	1120	110	9000
230	5600	220	29000

Graph 1 Electrical life, ops x 10⁶

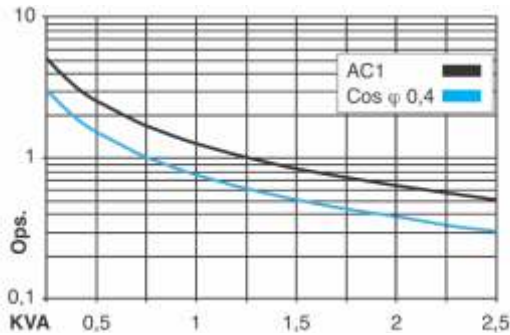

Graph 2 Max. DC load

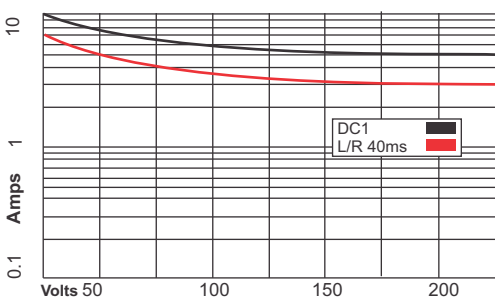

Dimensions in mm.

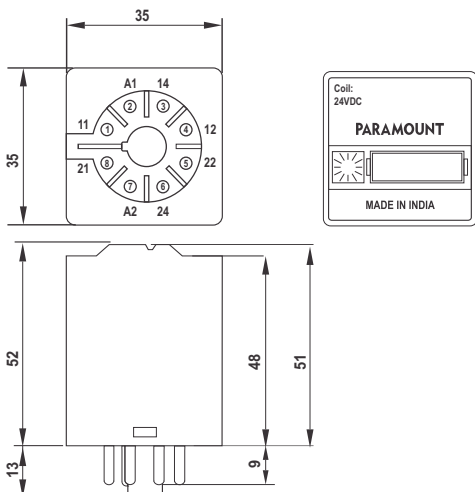

Insulation

Dielectric Strength (1 minute) : open contacts	1500 VAC
Between adjacent poles	2000 VAC
Between contacts and coil	2500 VAC
Insulation Resistance @ 500VDC Min.	200 MΩ
Isolation, IEC 61810-5	2.5 KV / 3

Specifications

Operate / Release & Bounce Time Max. for DC	16+3 / 3.5+8 ms
Operate / Release & Bounce Time Max. for AC	15+8 / 12+16 ms
Mechanical Life ops.	10 Million AC, 20 Million DC relays
Electrical life at Nominal load	≥ 100,000 ops.
Operating Frequency at nominal load	1200 / hour
Shock Resistance	AK : > 10g
Vibration Resistance	5g 10.....150 Hz
Mounting Direction	any
Storage	-40°C to +85°C
Ambient Operating Temperature	-40°C to +55°C (for AC relay)
Ambient Operating Temperature	-40°C to +70°C (for DC relay)
Protection Standard	IP 40
Weight	app. 80 g

Standard Types

AC : 6, 12, 24, 48, 110, 230	
M = Magnetic Blow Out	
P = LED Indicator	P3-2-PM VAC
R = RC Circuit	P3-2-PRM VAC
DC : 6, 12, 24, 48, 110, 220	
P = LED	P3-2-PM VDC
W = Free Wheeling Diode	P3-2-PWM VDC
Z = Polarity & Free Wheeling Diode	P3-2-PZM VDC
B = AC/DC Bridge Rectifier	P3-2-PBM VAD

Suitable Sockets : S8D, S8LD

Approvals





P3-2A....M



Magnetic Blow Out 2 NO Contacts

10 A 250V AC1 10 A 220V DC1
10 A 30V DC1 5 A 220V DC13

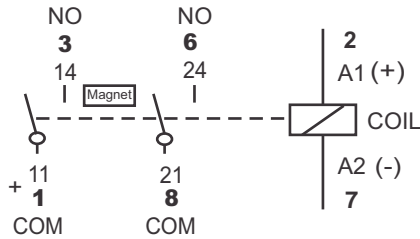

Contacts

Materials : Standard AgNi
Optional 1 AgNi + Au 0.2 μ
Optional 2 AgNi + Au 5.0 μ

Max. Switching Current 10A
Max. Peak Inrush Current (20 ms) 30A
Max. Switching Voltage 250 VAC
Switching Power range 0.3 VA (W) to 2500 VA
Max. Contact Resistance 20m Ω
Max. AC Load (Table 1) 2.5 KVA

Coils (Ohms ± @ 20°C)

Pull-in Voltage ≤ 0.8xUn
Drop-out Voltage ≥ 0.1xUn
Nominal Coil Power 1.6 VA (AC / 1.3 W (DC))

VAC	Ohms	VDC	Ohms
6	3.15	6	33
12	13.3	12	115
24	52	24	480
48	240	48	1850
110	1120	110	9000
230	5600	220	29000

Graph 1 Electrical life, ops x 10⁶

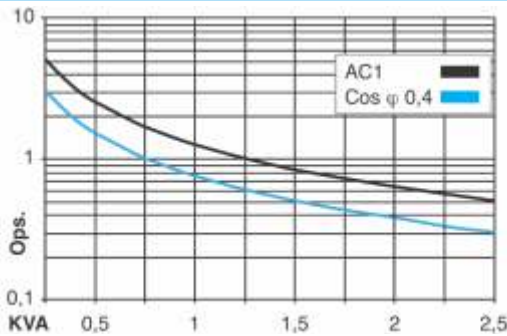

Graph 2 Max. DC load

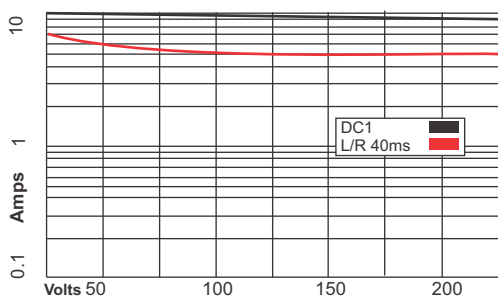

Insulation

Dielectric Strength (1 minute) : open contacts 2000 VAC
Between adjacent poles 2000 VAC
Between contacts and coil 2500 VAC
Insulation Resistance @ 500VDC Min. 200 MΩ
Isolation, IEC 61810-5 2.5 KV / 3

Specifications

Operate / Release & Bounce Time Max. for DC 20+3 ms
Operate / Release & Bounce Time Max. for AC 20+8 ms
Mechanical Life ops. 10 Million AC, 20 Million DC relays
Electrical life at Nominal load ≥ 100,000 ops.
Operating Frequency at nominal load 1200 / hour
Shock Resistance AK : > 10g
Vibration Resistance 5g 10.....150 Hz
Mounting Direction any
Storage -40°C to +85°C
Ambient Operating Temperature -40°C to +55°C (for AC relay)
Ambient Operating Temperature -40°C to +70°C (for DC relay)
Protection Standard IP 40
Weight app. 80 g

Dimensions in mm.

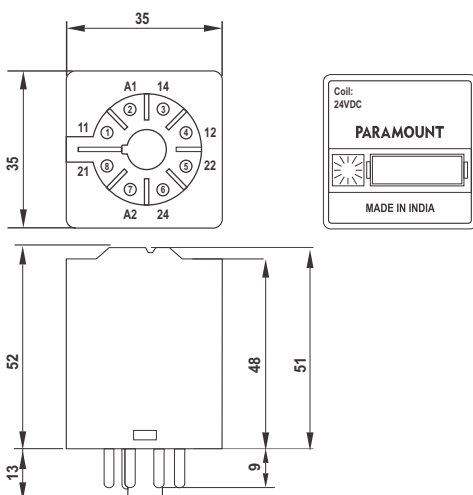

Standard Types

AC : 6, 12, 24, 48, 110, 230
M = Magnetic Blow Out
P = LED Indicator
R = RC Circuit

DC : 6, 12, 24, 48, 110, 220
P = LED
W = Free Wheeling Diode
Z = Polarity & Free Wheeling Diode
B = AC/DC Bridge Rectifier

P3-2A-PM VAC
P3-2A-PRM VAC

P3-2A-PM VDC
P3-2A-PWM VDC
P3-2A-PZM VDC
P3-2A-PBM VAD

Suitable Sockets : S8D-YA, S8LD-YA

Approvals





P3-X.....M



Magnetic Blow Out 1 NO + 1NC Contacts

10 A 250V AC1 10 A 220V DC1
10 A 30V DC1 5 A 220V DC13

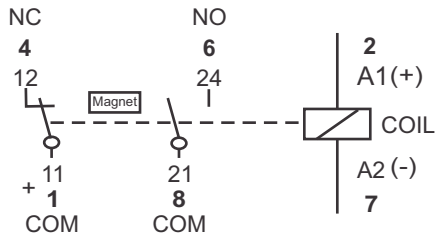

Graph 1 Electrical life, ops x 10⁶

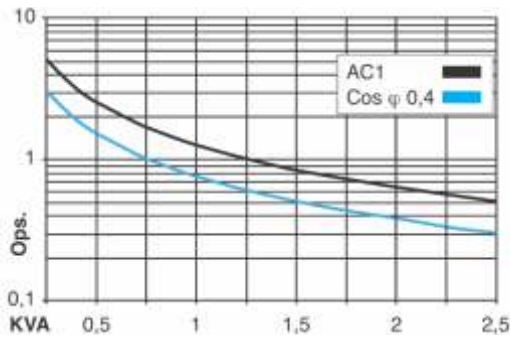

Graph 2 Max. DC load

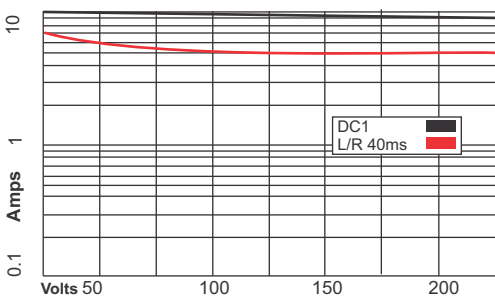

Dimensions in mm.

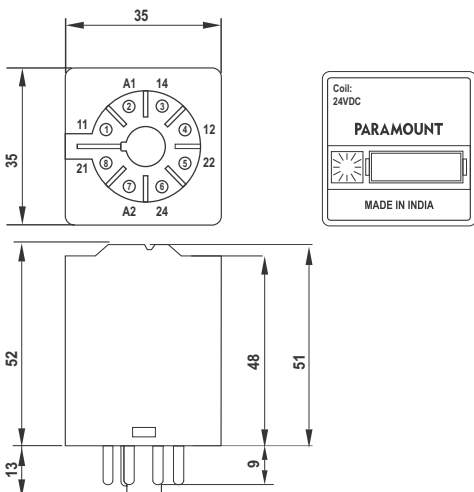

Contacts

Materials : Standard AgNi
Optional 1 AgNi + Au 0.2 μ
Optional 2 AgNi + Au 5.0 μ

Max. Switching Current 10A
Max. Peak Inrush Current (20 ms) 30A
Max. Switching Voltage 250 VAC
Switching Power range 0.3 VA (W) to 2500 VA
Max. Contact Resistance 20m Ω
Max. AC Load (Table 1) 2.5 KVA

Coils (Ohms ± @ 20°C)

Pull-in Voltage ≤ 0.8 x Un
Drop-out Voltage ≥ 0.1 x Un

Nominal Coil Power 1.6 VA (AC / 1.3 W (DC))

VAC	Ohms	VDC	Ohms
6	3.15	6	33
12	13.3	12	115
24	52	24	480
48	240	48	1850
110	1120	110	9000
230	5600	220	29000

Insulation

Dielectric Strength (1 minute) : open contacts 2000 VAC
Between adjacent poles 2000 VAC
Between contacts and coil 2500 VAC
Insulation Resistance @ 500VDC Min. 200 MΩ
Isolation, IEC 61810-5 2.5 KV / 3

Specifications

Operate / Release & Bounce Time Max. for DC 20+3 ms
Operate / Release & Bounce Time Max. for AC 20+8 ms
Mechanical Life ops. 10 Million AC, 20 Million DC relays
Electrical life at Nominal load ≥ 100,000 ops.
Operating Frequency at nominal load 1200 / hour
Shock Resistance AK : > 10g
Vibration Resistance 5g 10.....150 Hz
Mounting Direction any
Storage -40°C to +85°C
Ambient Operating Temperature -40°C to +55°C (for AC relay)
Ambient Operating Temperature -40°C to +70°C (for DC relay)
Protection Standard IP 40
Weight app. 80 g

Standard Types

AC : 6, 12, 24, 48, 110, 230

M = Magnetic Blow Out

P = LED Indicator

R = RC Circuit

DC : 6, 12, 24, 48, 110, 220

P = LED

W = Free Wheeling Diode

Z = Polarity & Free Wheeling Diode

B = AC/DC Bridge Rectifier

P3-X-PM VAC

P3-X-PRM VAC

P3-X-PM VDC

P3-X-PWM.... VDC

P3-X-PZM VDC

P3-X-PBM VAD

Suitable Sockets : S8D-X, S8LD-X

Approvals



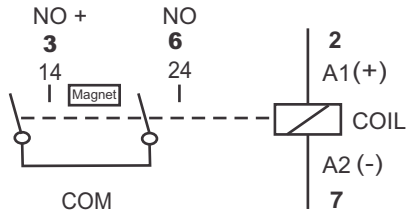

P3-Y....M



Magnetic Blow Out 1 NO Double Break

10 A 250V AC1 10 A 220V DC1
10 A 30V DC1 7 A 220V DC13

Contacts

Materials : Standard AgNi
Optional 1 AgNi + Au 0.2 μ
Optional 2 AgNi + Au 5.0 μ

Max. Switching Current 10A
Max. Peak Inrush Current (20 ms) 30A
Max. Switching Voltage 250 VAC
Switching Power range 0.3 VA (W) to 2500 VAz
Max. Contact Resistance 20m Ω
Max. AC Load (Table 1) 2.5 KVA

Coils (Ohms ± @ 20°C)

Pull-in Voltage ≤ 0.8 x Un
Drop-out Voltage ≥ 0.1 x Un

Nominal Coil Power 1.6 VA (AC / 1.3 W (DC))

VAC	Ohms	VDC	Ohms
6	3.15	6	33
12	13.3	12	115
24	52	24	480
48	240	48	1850
110	1120	110	9000
230	5600	220	29000

Graph 1 Electrical life, ops x 10⁶

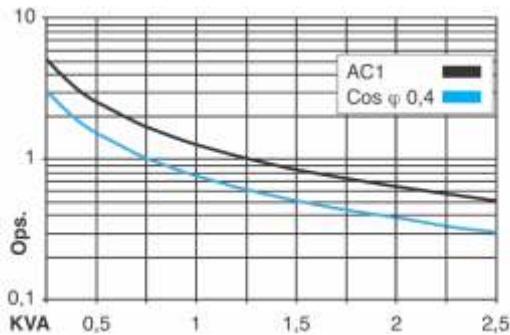

Graph 2 Max. DC load

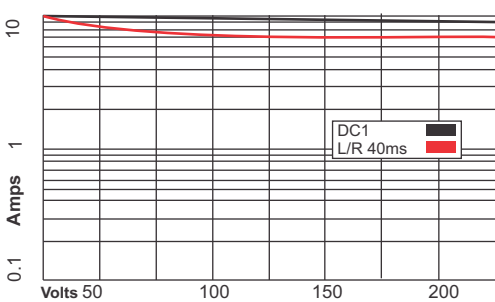

Dimensions in mm.

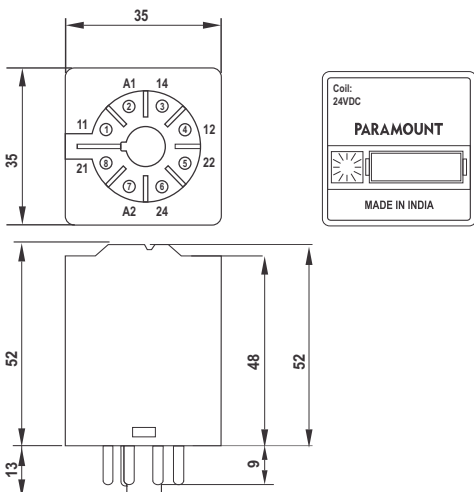

Insulation

Dielectric Strength (1 minute) : open contacts 1500 VAC
Between adjacent poles 2000 VAC
Between contacts and coil 2500 VAC
Insulation Resistance @ 500VDC Min. 200 MΩ
Isolation, IEC 61810-5 2.5 KV / 3

Specifications

Operate / Release & Bounce Time Max. for DC 15+3 ms
Operate / Release & Bounce Time Max. for AC 16+8 ms
Mechanical Life ops. 10 Million AC, 20 Million DC relays
Electrical life at Nominal load ≥ 100,000 ops.
Operating Frequency at nominal load 1200 / hour
Shock Resistance AK : > 10g
Vibration Resistance 5g 10.....150 Hz
Mounting Direction any
Storage -40°C to +85°C
Ambient Operating Temperature -40°C to +55°C (for AC relay)
Ambient Operating Temperature -40°C to +70°C (for DC relay)
Protection Standard IP 40
Weight app. 80 g

Standard Types

AC : 6, 12, 24, 48, 110, 230

M = Magnetic Blow Out

P = LED Indicator

R = RC Circuit

P3-Y-PM VAC

P3-Y-PRM VAC

DC : 6, 12, 24, 48, 110, 220

P = LED

W = Free Wheeling Diode

Z = Polarity & Free Wheeling Diode

B = AC/DC Bridge Rectifier

P3-Y-PM VDC

P3-Y-PWM VDC

P3-Y-PZM VDC

P3-Y-PBM VAD

Suitable Sockets : S8D-YA, S8LD-YA

Approvals



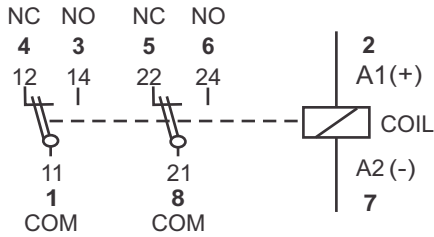

Graph 1 Electrical life, ops x 10⁶

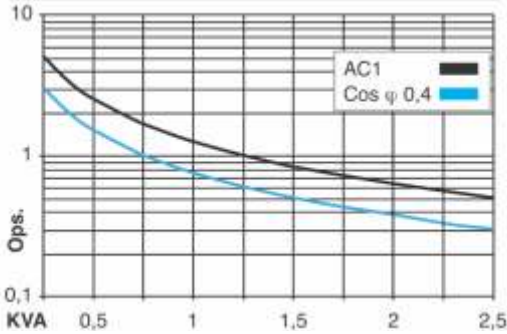

Graph 2 Max. DC load

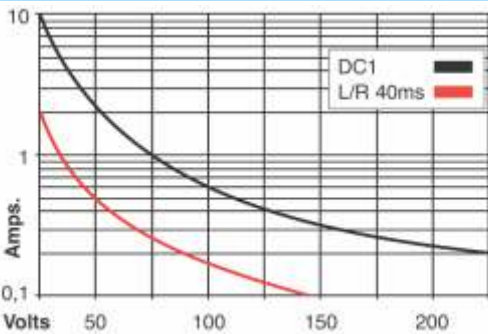

Dimensions in mm.

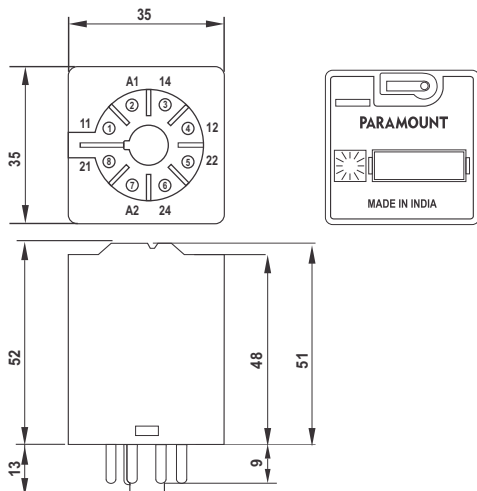

P3-2T



2C/O Bifurcated Contacts

6 A 250V AC1 0.5 A 110V DC1
6 A 30V DC1 0.2 A 220V DC1

Contacts

Materials : Standard AgNi
Optional 1 AgNi + Au 0.2 μ
Optional 2 AgNi + Au 5.0 μ
Max. Switching Current 6A
Max. Peak Inrush Current (20 ms) 30A
Max. Switching Voltage 250 VAC
Switching Power range 0.3 VA (W) to 2500 VAzC
Max. Contact Resistance 20m Ω
Max. AC Load (Table 1) 2.5 KVA
Max. DC Load (See Table 2) -

Coils (Ohms ± @ 20°C)

Pull-in Voltage ≤ 0.8xUn
Drop-out Voltage ≥ 0.1xUn
Nominal Coil Power 1.6 VA (AC / 1.3 W (DC))

VAC	Ohms	VDC	Ohms
6	3.15	6	33
12	13.3	12	116
24	52	24	480
46	240	46	1850
110	1120	110	9000
230	5600	220	29000

Insulation

Dielectric Strength (1 minute) : open contacts 1500 VAC
Between adjacent poles 2000 VAC
Between contacts and coil 2500 VAC
Insulation Resistance @ 500VDC Min. 200 MΩ
Isolation, IEC 61810-5 2.5 KV / 3

Specifications

Operate / Release & Bounce Time Max. for DC 8+3 / 3.5+8 ms
Operate / Release & Bounce Time Max. for AC 9+8 / 12+16 ms
Mechanical Life ops. 10 Million AC, 20 Million DC relays
Electrical life at Nominal load ≥ 100,000 ops.
Operating Frequency at nominal load 1200 / hour
Shock Resistance AK : > 10g
Vibration Resistance 5g 10.....150 Hz
Mounting Direction any
Storage -40°C to +85°C
Ambient Operating Temperature -40°C to +55°C (for AC relay)
Ambient Operating Temperature -40°C to +70°C (for DC relay)
Protection Standard IP 40
Weight app. 80 g

Standard Types

AC : 6, 12, 24, 48, 110, 230

T = Twin Contact

F = Mechanical Flag Indicator

P = LED Indicator

I = Lockable Push Button

R = RC Circuit

DC : 6, 12, 24, 48, 110, 220

F = Mechanical Flag Indicator

P = LED

I = Lockable Push Button

W = Free Wheeling Diode

Z = Polarity & Free Wheeling Diode

B = AC/DC Bridge Rectifier

P3-2T-F VAC
P3-2T-FP VAC
P3-2T-FPI VAC
P3-2T-FIR VAC

P3-2T-F VDC
P3-2T-FP VDC
P3-2T-FPI VDC
P3-2T-FPWI VDC
P3-2T-FPZI VDC
P3-2T-FPIB VAD

Suitable Sockets : S8D, S8LD

Approvals



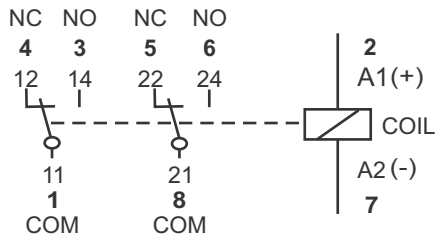

Graph 1 Electrical life, ops x 10⁶

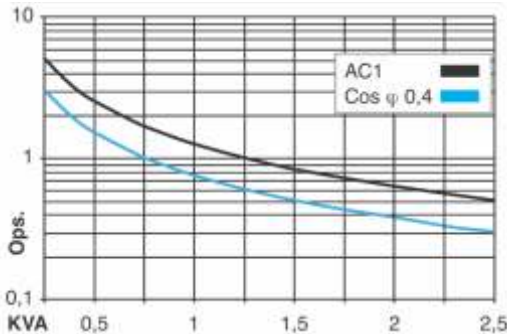

Graph 2 Max. DC load

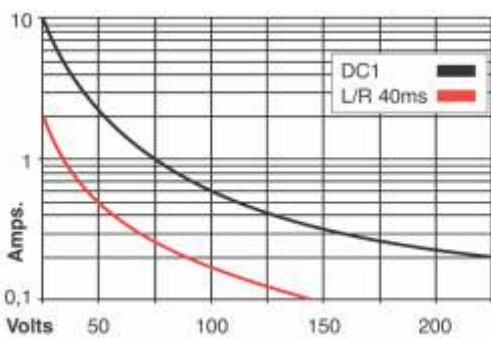

Dimensions in mm.

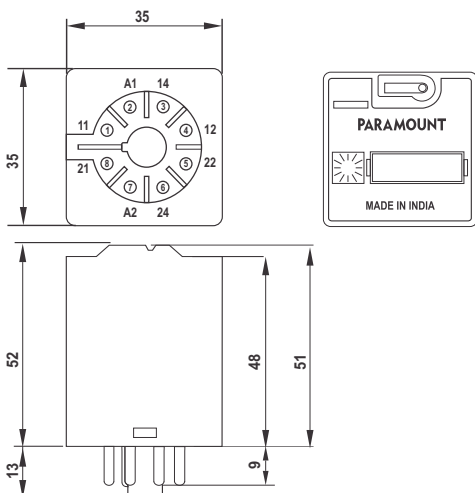

P3-2....H



Long Life Relay 2C/O Contacts

10 A 250V AC1 0.5 A 110VDC1
10 A 30V DC1 0.2 A 220VDC1

Contacts

Materials : Standard AgNi
Optional 1 AgNi + Au 0.2 μ
Optional 2 AgNi + Au 5.0 μ

Max. Switching Current 10A
Max. Peak Inrush Current (20 ms) 30A
Max. Switching Voltage 250 VAC
Switching Power range 0.3 VA (W) to 2500 VAz
Max. Contact Resistance 20m Ω
Max. AC Load (Table 1) 2.5 KVA
Max. DC Load (See Table 2) -

Coils (Ohms ± @ 20°C)

Pull-in Voltage ≤ 0.8xUn
Drop-out Voltage ≥ 0.1xUn
Nominal Coil Power 1.6 VA (AC / 1.3 W (DC))

VAC	Ohms	VDC	Ohms
6	3.15	6	33
12	13.3	12	115
24	52	24	480
48	240	48	1850
110	1120	110	9000
230	5600	220	29000

Insulation

Dielectric Strength (1 minute) : open contacts 1500 VAC
Between adjacent poles 2000 VAC
Between contacts and coil 2500 VAC
Insulation Resistance @ 500VDC Min. 200 MΩ
Isolation, IEC 61810-5 2.5 KV / 3

Specifications

Operate / Release & Bounce Time Max. for DC 8+3 / 3.5+8 ms
Operate / Release & Bounce Time Max. for AC 9+8 / 12+16 ms
Mechanical Life ops. 10 Million AC, 20 Million DC relays
Electrical life at Nominal load ≥ 700,000 ops.
Operating Frequency at nominal load 1200 / hour
Shock Resistance AK : > 10g
Vibration Resistance 5g 10.....150 Hz
Mounting Direction any
Storage -40°C to +85°C
Ambient Operating Temperature -40°C to +55°C (for AC relay)
Ambient Operating Temperature -40°C to +70°C (for DC relay)
Protection Standard IP 40
Weight app. 80 g

Standard Types

AC : 6, 12, 24, 48, 110, 230

H = Long Life Relay

F = Mechanical Flag Indicator

P = LED Indicator

I = Lockable Push Button

R = RC Circuit

DC : 6, 12, 24, 48, 110, 220

F = Mechanical Flag Indicator

P = LED

I = Lockable Push Button

W = Free Wheeling Diode

Z = Polarity & Free Wheeling Diode

B = AC/DC Bridge Rectifier

P3-2-F-H VAC

P3-2-FP-H VAC

P3-2-FPI-H VAC

P3-2-FIR-H VAC

P3-2-F-H VDC

P3-2-FP-H VDC

P3-2-FPI-H VDC

P3-2-FPWI-H VDC

P3-2-FPZI-H VDC

P3-2-FPIB-H VAD

Suitable Sockets : S8D

Approvals



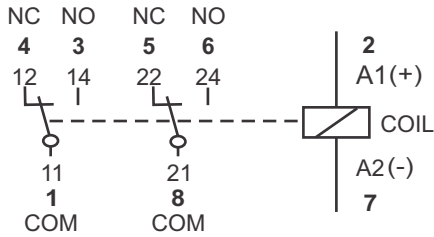

Graph 1 Electrical life, ops x 10⁶

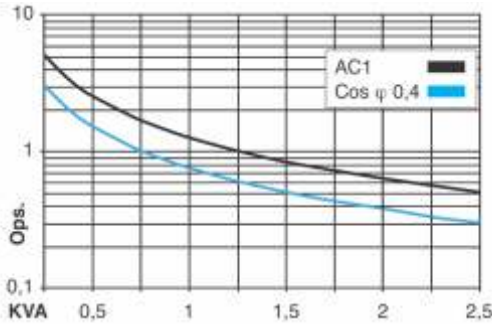

Graph 2 Max. DC load

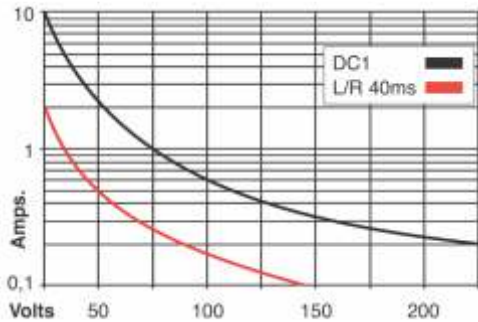

Dimensions in mm.

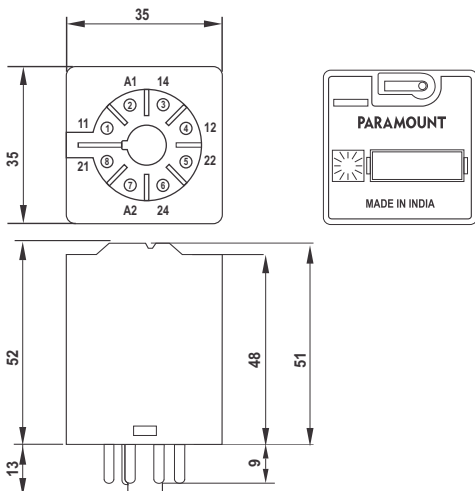

P3-2.....E



6Amps Relays - 2C/O Contacts

6 A 250V AC 10.5 A 110V DC1
6 A 30V DC1 0.2 A 220V DC1

Contacts

Materials : Standard
Optional 1
Optional 2

Max. Switching Current
Max. Peak Inrush Current (20 ms)
Max. Switching Voltage
Switching Power range
Max. Contact Resistance
Max. AC Load (Table 1)
Max. DC Load (See Table 2)

AgNi
AgNi + Au 0.2 μ
AgNi + Au 5.0 μ
6A
30A
250 VAC
0.3 VA (W) to 2500 VA
20m Ω
2.5 KVA
-

Coils (Ohms ± @ 20°C)

Pull-in Voltage ≤ 0.8xUn
Drop-out Voltage ≥ 0.1xUn
Nominal Coil Power 1.6 VA (AC / 1.3 W (DC))

VAC	Ohms	VDC	Ohms
6	3.15	6	33
12	13.3	12	115
24	52	24	480
48	240	48	1850
110	1120	110	9000
230	5600	220	29000

Insulation

Dielectric Strength (1 minute) : open contacts 1500 VAC
Between adjacent poles 2000 VAC
Between contacts and coil 2500 VAC
Insulation Resistance @ 500VDC Min. 200 MΩ
Isolation, IEC 61810-5 2.5 KV / 3

Specifications

Operate / Release & Bounce Time Max. for DC 8+3 / 3.5+8 ms
Operate / Release & Bounce Time Max. for AC 9+8 / 12+16 ms
Mechanical Life ops. 10 Million AC, 20 Million DC relays
Electrical life at Nominal load ≥ 100,000 ops.
Operating Frequency at nominal load 1200 / hour
Shock Resistance AK : > 10g
Vibration Resistance 5g 10.....150 Hz
Mounting Direction any
Storage -40°C to +85°C
Ambient Operating Temperature -40°C to +55°C (for AC relay)
Ambient Operating Temperature -40°C to +70°C (for DC relay)
Protection Standard IP 40
Weight app. 80 g

Standard Types

AC : 6, 12, 24, 48, 110, 230

E = 6 Amps Relay

F = Mechanical Flag Indicator

P = LED Indicator

I = Lockable Push Button

R = RC Circuit

DC : 6, 12, 24, 48, 110, 220

F = Mechanical Flag Indicator

P = LED

I = Lockable Push Button

W = Free Wheeling Diode

Z = Polarity & Free Wheeling Diode

B = AC/DC Bridge Rectifier

P3-2-F-E VAC

P3-2-FP-E VAC

P3-2-FPI-E VAC

P3-2-FIR-E VAC

P3-2-F-E VDC

P3-2-FP-E VDC

P3-2-FPI-E VDC

P3-2-FPWI-E VDC

P3-2-FPZI-E VDC

P3-2-FPIB-E VAD

Suitable Sockets : S8D, S8LD

Approvals





S8D

Only
38 mm
WIDE

**Socket Din Rail or Panel Mountable
for P3 2c/o Relay**

Wiring diagram

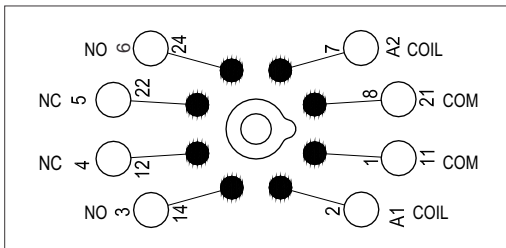

Specifications

Poles: 2 Change Over Contact (8pins)
Nominal load : 10A / 250V

Insulation: Di-electric strength, 1minute

Between contact and coil	2.5 KV
Between all terminals and DIN Rail	2.5 KV
Between adjacent terminals	2.5 KV

Max. screw torque	0.5 Nm
Screw dimensions	M3, Pozi

Wire in-lets capacity:

Solid Wire	4sq mm or 2 x 2.25 mm
Multi core	22 14 AWG
Ferrule tip terminals	4 mm sq

Weight Approx.	47 gms.
----------------	---------

Dimensions in mm

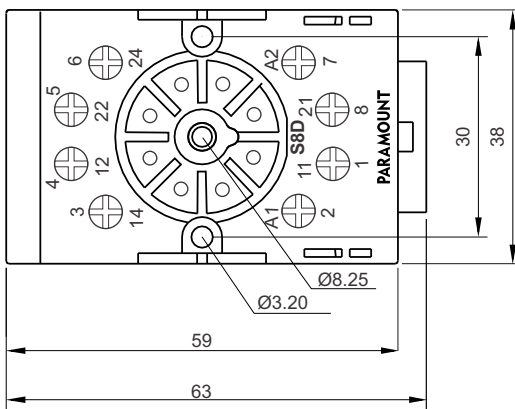
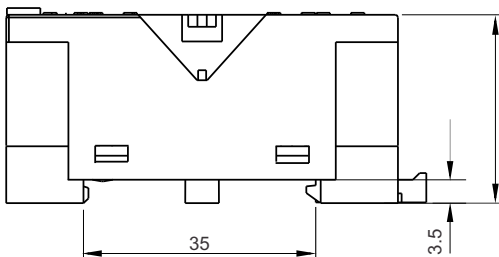

Other Aspects

- DIN Rail / Panel Mountable
- EN / DIN Sequential Numbering according to EN 60947 & IEC 61810
- Integrated Relay Hold Down Clip
- Removable White Marking Label
- Hard Brass Tin Plated Terminals
- Brass Tin Plated Screws

Approvals



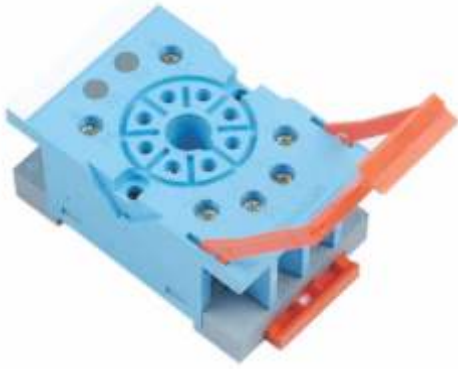

S8D-YA

Only
38 mm
WIDE

**Socket DIN Rail or Panel Mountable
for P3 2N/O & 1NO Double Break Relays**

Wiring diagram

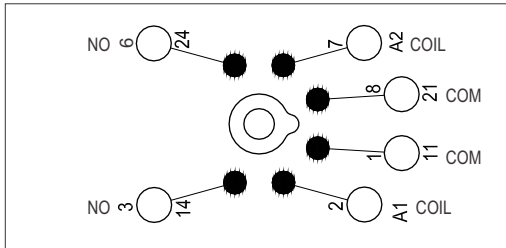

Specifications

Poles 2 N/O & 1NO Double Break Contact (8pins)
Nominal load : 10A / 250V

Insulation: Di-electric strength, 1minute
Between contact and coil 2.5 KV
Between all terminals and DIN Rail 2.5 KV
Between adjacent terminals 2.5 KV

Max. screw torque 0.5 Nm
Screw dimensions M3, Pozi

Wire in-lets capacity:
Solid Wire 4sq mm or 2 x 2.25 mm
Multi core 22 14 AWG
Ferrule tip terminals 4 mm sq

Weight Approx. 47 gms.

Dimensions in mm

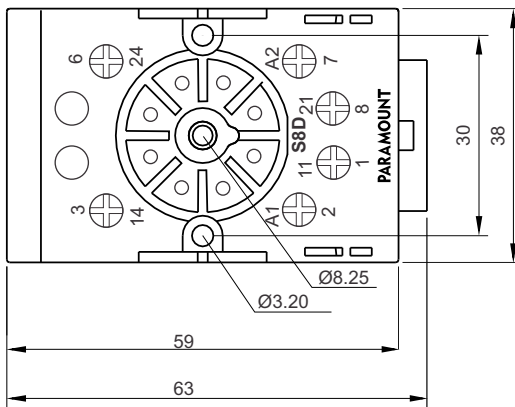
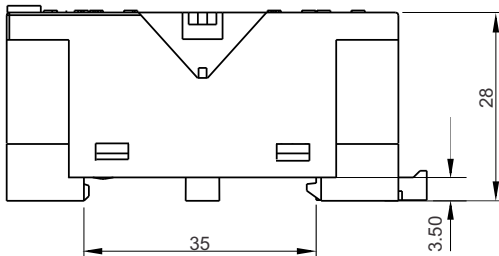

Other Aspects

- DIN Rail / Panel Mountable
- EN / DIN Sequential Numbering according to EN 60947 & IEC 61810
- Integrated Relay Hold Down Clip
- Removable White Marking Label
- Hard Brass Tin Plated Terminals
- Brass Tin Plated Screws

Approvals



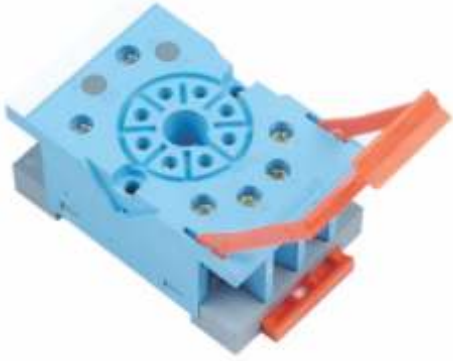

S8D-X

Only
38 mm
WIDE

**Socket DIN Rail or Panel Mountable
for P3 1NO + 1NC Relay**

Wiring diagram

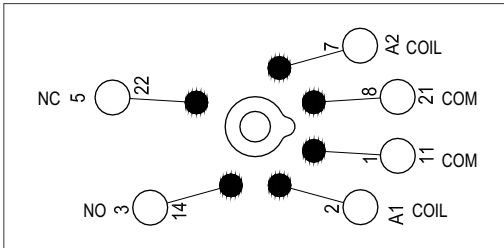

Specifications

Poles: 1 NO + 1NC Contact (8pins)
Nominal load : 10A / 250V

Insulation: Di-electric strength, 1minute
Between contact and coil: 2.5 KV
Between all terminals and DIN Rail: 2.5 KV
Between adjacent terminals: 2.5 KV

Max. screw torque: 0.5 Nm
Screw dimensions: M3, Pozi

Wire in-lets capacity:
Solid Wire: 4sq mm or 2 x 2.25 mm
Multi core: 22 14 AWG
Ferrule tip terminals: 4 mm sq

Weight Approx. 47 gms.

Dimensions in mm

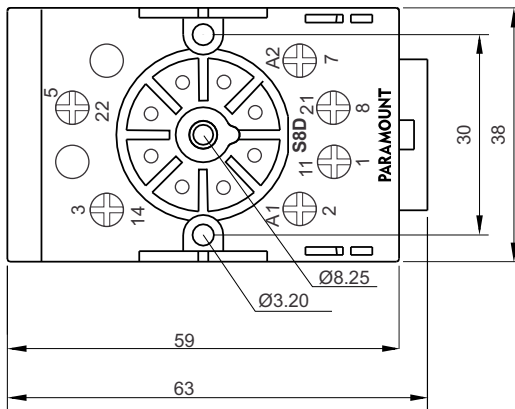
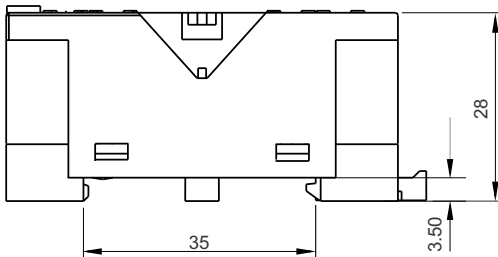

Other Aspects

- DIN Rail / Panel Mountable
- EN / DIN Sequential Numbering according to EN 60947 & IEC 61810
- Integrated Relay Hold Down Clip
- Removable White Marking Label
- Hard Brass Tin Plated Terminals
- Brass Tin Plated Screws

Approvals



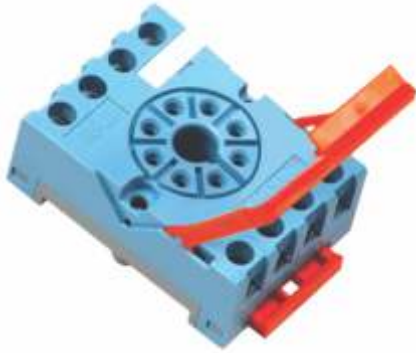

S8LD

Only
38 mm
WIDE

Socket for P3 2c/o Relay
DIN Rail or Panel Mountable

Wiring diagram

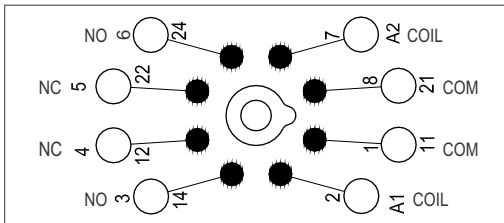

Dimensions in mm

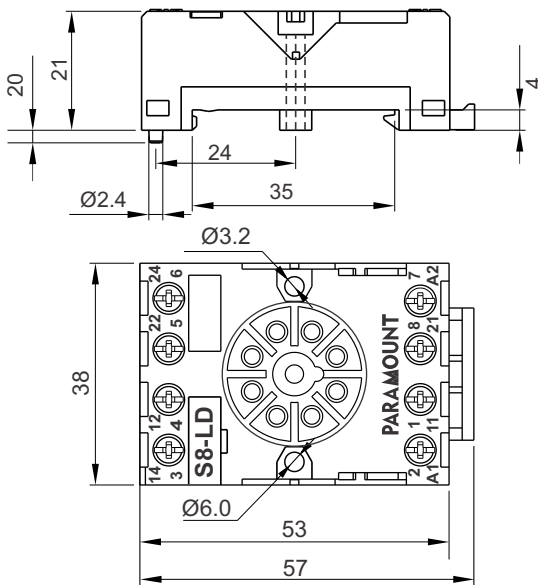

Specifications

Poles 2 Change Over Contact (8pins)
Nominal load : 10A / 250V

Insulation: Di-electric strength, 1minute

Between contact and coil	2.5 KV
Between all terminals and DIN Rail	2.5 KV
Between adjacent terminals	2.5 KV

Max. screw torque	0.5 Nm
Screw dimensions	M3, Pozi
Weight Approx.	47 gms.

Other Aspects

DIN Rail / Panel Mountable
EN / DIN Sequential Numbering according to
EN 60947 & IEC 61810
Integrated Relay Hold Down Clip
Removable White Marking Label

Accessories



S8LD-B1



C Terminal

Accessories

S8LD-B1 - 1 Way Bridge

Fork / C - Terminal for wire connection

Dimensions in mm.

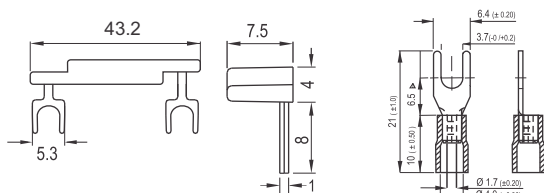

S8LD-B1
1 Way Bridge for Coil

Fork / C type crimped Terminal
used for wire connection

Approvals



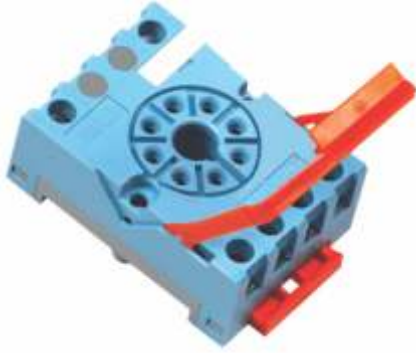

S8LD-YA

Only
38 mm
WIDE

**Socket DIN Rail or Panel Mountable
for P3 2N/O & 1NO Double Break Relays**

Wiring diagram

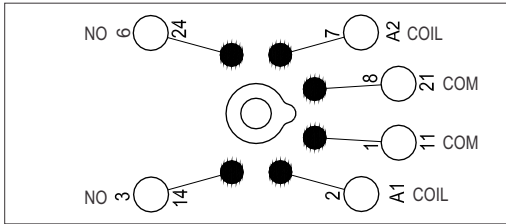

Dimensions in mm

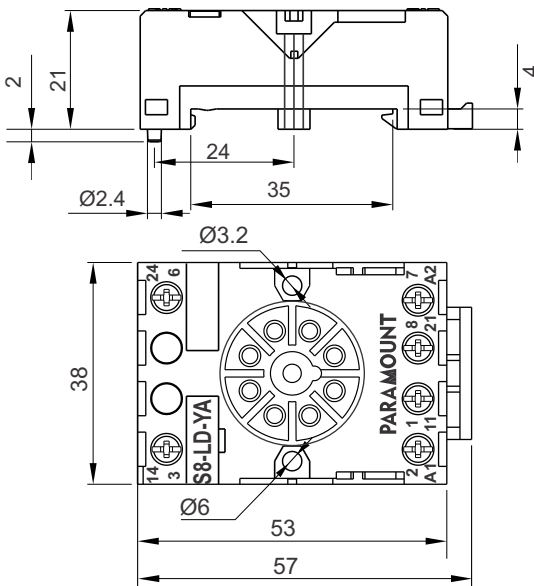

Specifications

Poles: 2 N/O & 1NO Double Break Contact (8pins)
Nominal load: 10A / 250V

Insulation: Di-electric strength, 1minute
Between contact and coil: 2.5 KV
Between all terminals and DIN Rail: 2.5 KV
Between adjacent terminals: 2.5 KV

Max. screw torque: 0.5 Nm
Screw dimensions: M3, Pozi
Weight Approx.: 47 gms.

Other Aspects

DIN Rail / Panel Mountable
EN / DIN Sequential Numbering according to
EN 60947 & IEC 61810
Integrated Relay Hold Down Clip
Removable White Marking Label

Accessories



Accessories

S8LD-B1 - 1 Way Bridge
Fork / C - Terminal for wire connection

Dimensions in mm.

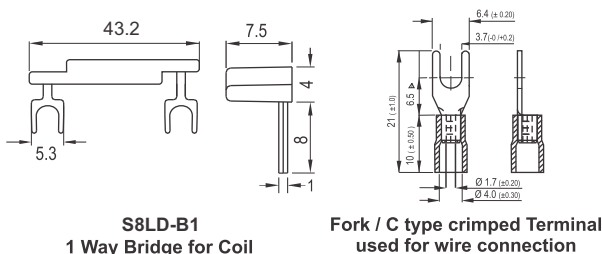

Approvals



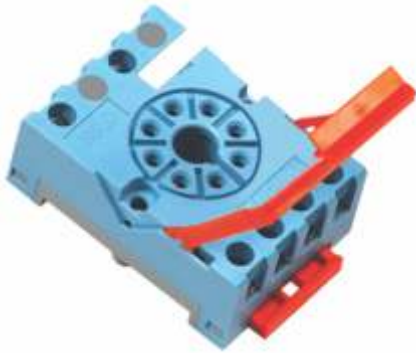

S8LD-X

Only
38 mm
WIDE

**Socket DIN Rail or Panel Mountable
for P3 1NO + 1NC Relay**

Wiring diagram

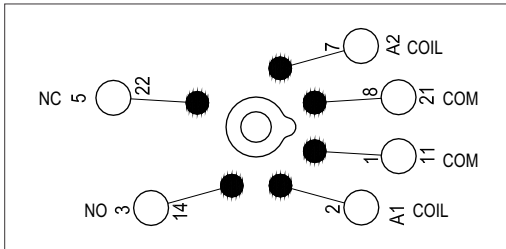

Dimensions in mm

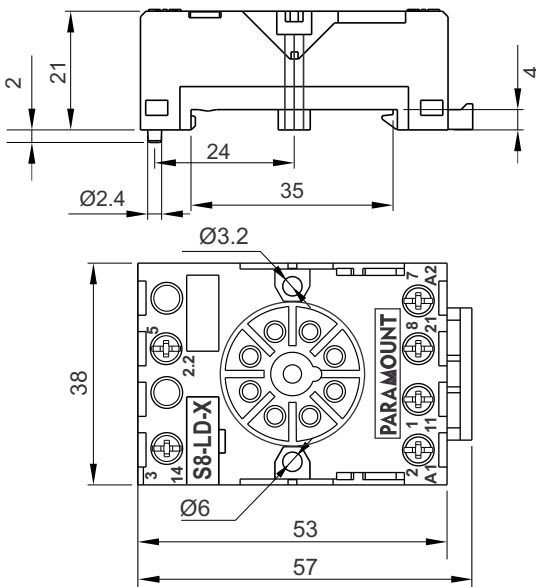

Specifications

Poles	1 NO + 1NC Contact (8pins)
Nominal load :	10A / 250V
Insulation: Di-electric strength, 1minute	
Between contact and coil	2.5 KV
Between all terminals and DIN Rail	2.5 KV
Between adjacent terminals	2.5 KV
Max. screw torque	0.5 Nm
Screw dimensions	M3, Pozi
Weight Approx.	47 gms.

Other Aspects

- DIN Rail / Panel Mountable
- EN / DIN Sequential Numbering according to EN 60947 & IEC 61810
- Integrated Relay Hold Down Clip
- Removable White Marking Label

Accessories



S8LD-B1



C Terminal

Accessories

- S8LD-B1 - 1 Way Bridge
- Fork / C - Terminal for wire connection

Dimensions in mm.

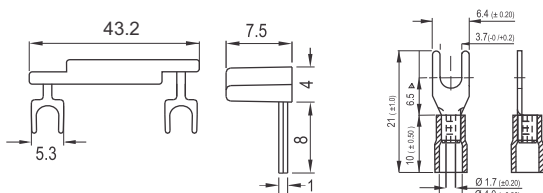

S8LD-B1
1 Way Bridge for Coil

Fork / C type crimped Terminal
used for wire connection

Approvals



Ordering Information

P3 - - - - - - -
1 2 3 4 5 6 7

1. Relay Type

Blank : General Purpose 2 Pole Relay / Standard

2. Contact Form

2 : DPT (2C/O)
2A : 2 NO
X : 1 NO + 1 NC &
Y : 1 NO Double Break

3. Contact Type

Blank : Single
T : Twin Contact

4. Features

F : Mechanical operation Indicator
P : LED Indicator
Z : Free Wheeling + Polarity Diode
I : Lockable Push Button & Manual Push Button
B : Bridge Rectifier
R : RC circuit
W : Free Wheeling Diode

5. Special Types

Blank : Standard (contact rating of 10Amps @ 250VAC)
M : Magnetic Blow Out
H : Long Life (700,000 operations)
E : Contact Rating of 6Amps@250VAC

6. Contact Material

Blank : AgNi
1. : AgNi + Au 0.2 μ (only for Twin contacts)
2. : AgNi + Au 5.0 μ (only for Twin contacts)

7. Rated Coil Voltage

6 / 12 / 24 / 48 / 110 / 220 - VDC
6 / 12 / 24 / 48 / 115 / 230 - VAC

NOTE:-

- A. For Current coil please specify AC/DC coil current in place of coil voltage
- B. Standard Frequency is 50 Hz for AC coil, for other frequency please specify frequency after coil voltage

Paramount Industries

#70, 5th Cross, SSI Area, Rajajinagar,
Bangalore - 560 010, India.

Tel : +91-80-22970010, 22970011, 23150828

Fax : +91-80-23302574, 28520623

Email : info@paramount.net.in

Website : www.paramount.net.in